

## Thyristors

### SKT 1400 SKT 2000



#### Features

- Hermetic metal cases with ceramic insulators
- Amplifying gates
- Capsule packages for double sided cooling
- Shallow design with single sided cooling
- Off-state and reverse voltages up to 3600 V

#### Typical Applications

- DC motor control (e. g. for machine tools)
- Controlled rectifiers (e. g. for battery charging)
- AC controllers (e. g. for temperature control)
- Soft starters for AC motors

V <sub>RSM</sub>	V <sub>RRM</sub> V <sub>DRM</sub>	$\left(\frac{dv}{dt}\right)_{cr}$	I <sub>TRMS</sub> (maximum values for continuous operation)	
			3000 A	5000 A
V	V	V/μs	I <sub>TAV</sub> (sin. 180; T <sub>case</sub> = ... ; DSC)	
			1500 A (55 °C)	2450 A (55 °C)
2300	2200	1000	–	<b>SKT 2000/22 E</b>
2700	2600	1000	<b>SKT 1400/26 E</b>	<b>SKT 2000/26 E</b>
2900	2800	1000	<b>SKT 1400/28 E</b>	<b>SKT 2000/28 E</b>
3300	3200	1000	<b>SKT 1400/32 E</b>	–
3700	3600	1000	<b>SKT 1400/36 E</b>	–

Symbol	Conditions	SKT 1400	SKT 2000
I <sub>TAV</sub>	sin. 180; (T <sub>case</sub> = ...); DSC	1400 A (62 °C)	2000 A (72 °C)
I <sub>TSM</sub>	T <sub>vj</sub> = 25 °C T <sub>vj</sub> = 125 °C	29 000 A 25 000 A	45 000 A 39 000 A
i <sup>2</sup> t	T <sub>vj</sub> = 25 °C T <sub>vj</sub> = 125 °C	4 200 000 A <sup>2</sup> s 3 125 000 A <sup>2</sup> s	10 125 000 A <sup>2</sup> s 7 600 000 A <sup>2</sup> s
t <sub>gd</sub>	T <sub>vj</sub> = 25 °C; I <sub>G</sub> = 1 A; di <sub>G</sub> /dt = 1 A/μs		typ. 1 μs
t <sub>gr</sub>	V <sub>D</sub> = 0,67 · V <sub>DRM</sub>		typ. 2 μs
(di/dt) <sub>cr</sub>	f = 50 ... 60 Hz		150 A/μs
I <sub>H</sub>	T <sub>vj</sub> = 25 °C; typ./max.		500 mA/1 A
I <sub>L</sub>	T <sub>vj</sub> = 25 °C; typ./max.		2 A/5 A
t <sub>q</sub>	T <sub>vj</sub> = 125 °C; typ.		200 ... 300 μs
V <sub>T</sub>	T <sub>vj</sub> = 25 °C; I <sub>T</sub> = 3000 A; max.	2,1 V	1,8 V
V <sub>T(TO)</sub>	T <sub>vj</sub> = 125 °C	1,04 V	1,09 V
r <sub>T</sub>	T <sub>vj</sub> = 125 °C	0,35 mΩ	0,236 mΩ
I <sub>DD</sub> , I <sub>RD</sub>	T <sub>vj</sub> = 125 °C; V <sub>DD</sub> = V <sub>DRM</sub> ; V <sub>RD</sub> = V <sub>RRM</sub>	100 mA	100 mA
V <sub>GT</sub>	T <sub>vj</sub> = 25 °C		3 V
I <sub>GT</sub>	T <sub>vj</sub> = 25 °C		300 mA
V <sub>GD</sub>	T <sub>vj</sub> = 125 °C		0,25 V
I <sub>GD</sub>	T <sub>vj</sub> = 125 °C		10 mA
R <sub>thjc</sub>	cont. DSC sin. 180; DSC/SSC rec. 120; DSC/SSC	} °C/W	0,018 0,0185/0,039 0,020/0,041
R <sub>thch</sub>	DCS/SSC		0,0105 0,0110/0,0240 0,0118/0,0250
T <sub>vj</sub>			– 40 ... +125 °C
T <sub>stg</sub>			– 40 ... +130 °C
F	SI units	27 ... 34 kN	37 ... 47 kN
w	US units	6000 ... 7600 lbs.	8000 ... 10000 lbs
Case		B 19	B 20

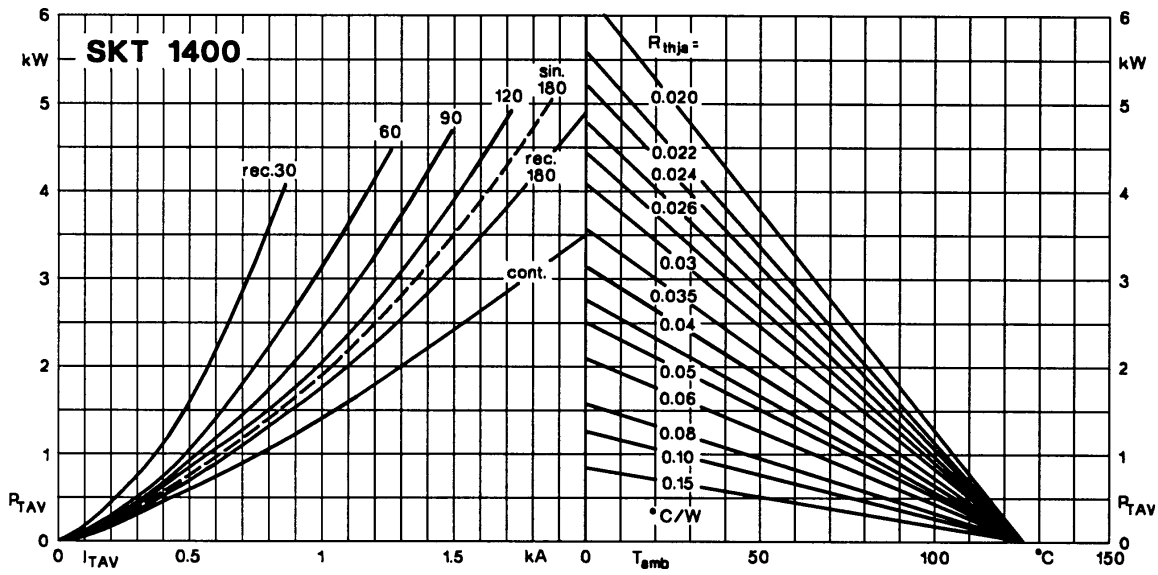

Fig. 1 a Power dissipation vs. on-state current and ambient temperature

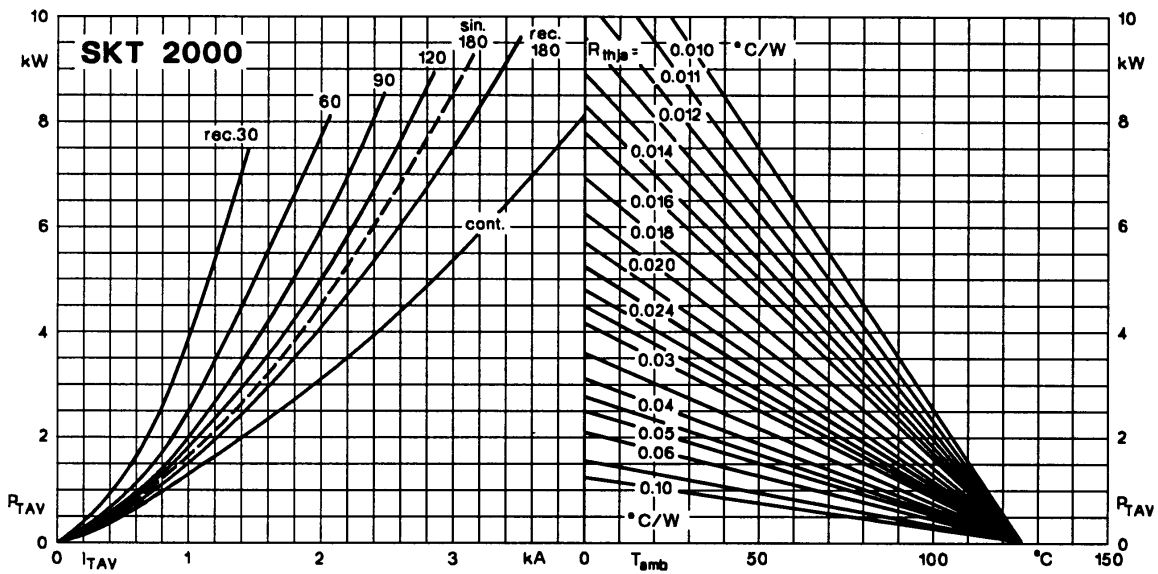

Fig. 1 b Power dissipation vs. on-state current and ambient temperature

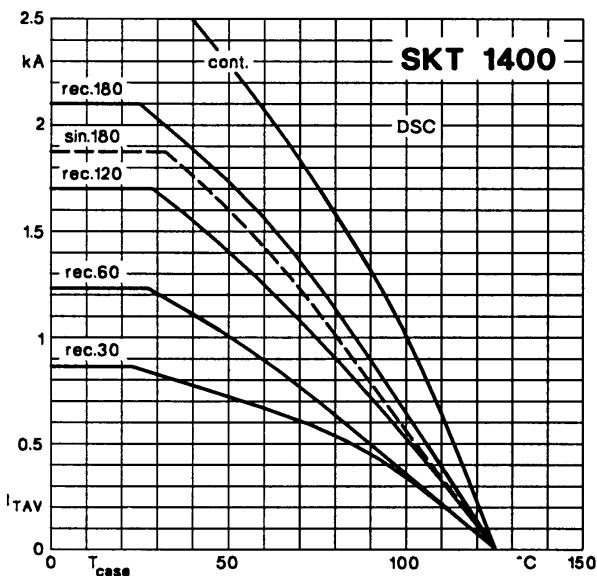

Fig. 2 a Rated on-state current vs. case temperature

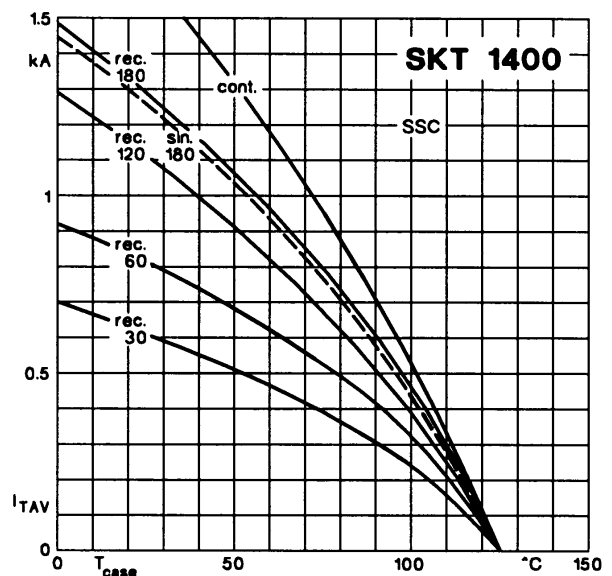

Fig. 2 b Rated on-state current vs. case temperature

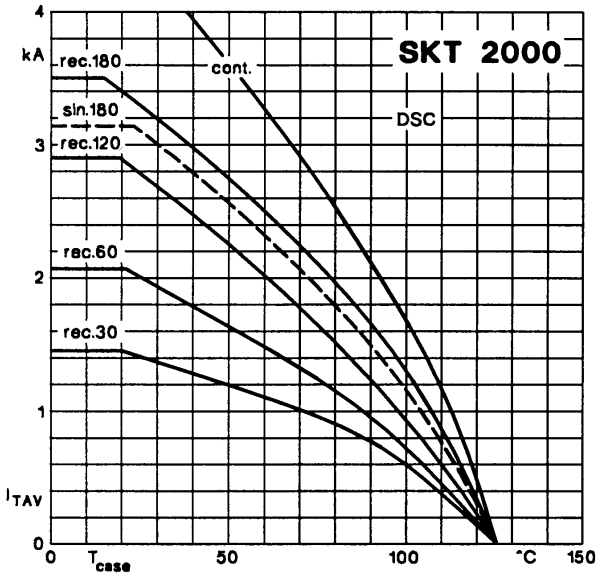

Fig. 2 c Rated on-state current vs. case temperature

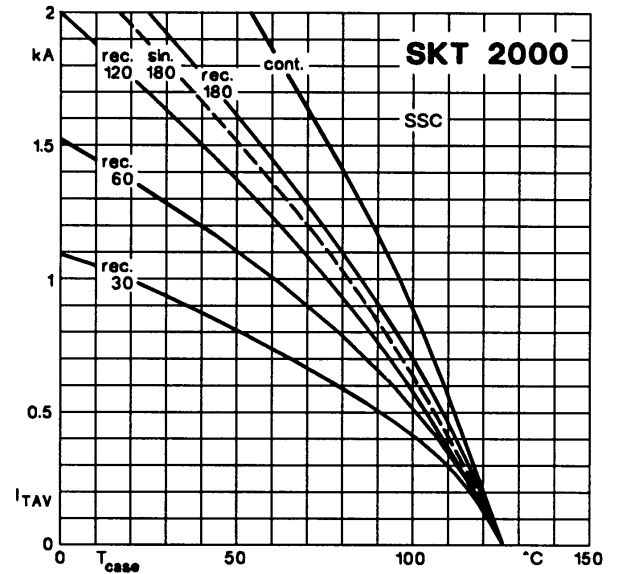

Fig. 2 d Rated on-state current vs. case temperature

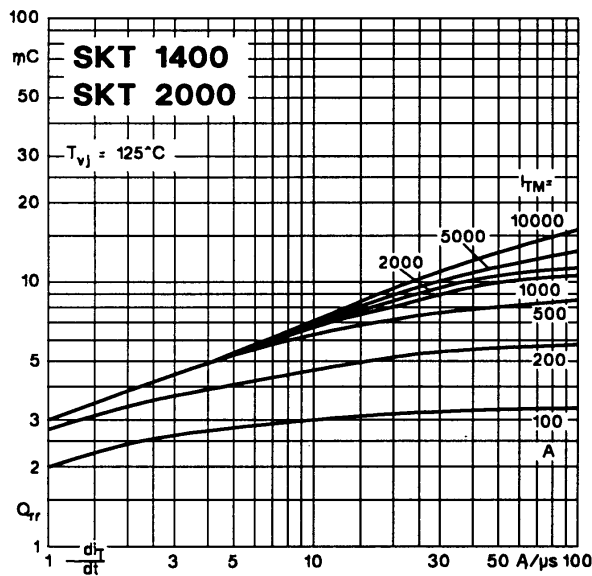

Fig. 3 Recovered charge vs. current decrease

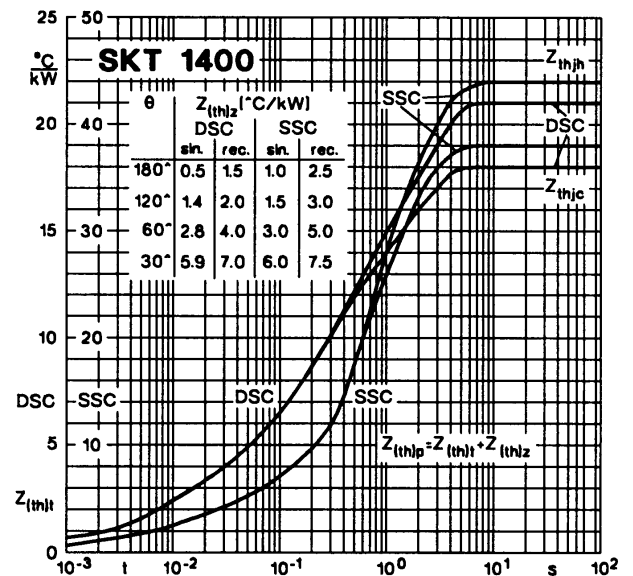

Fig. 4 a Transient thermal impedance vs. time

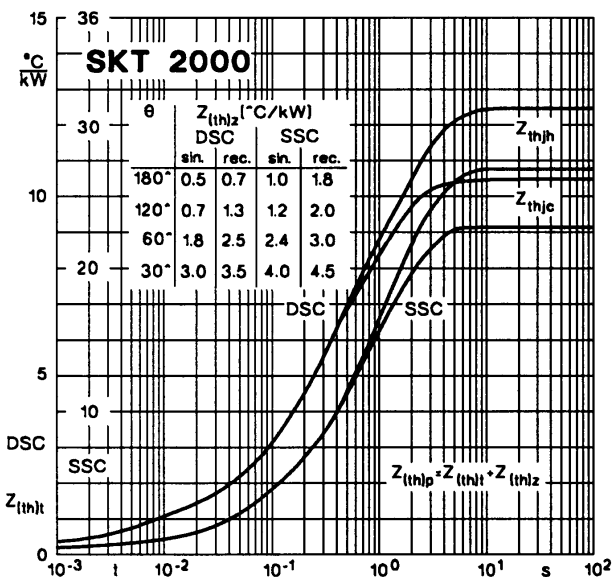

Fig. 4 b Transient thermal impedance vs. time

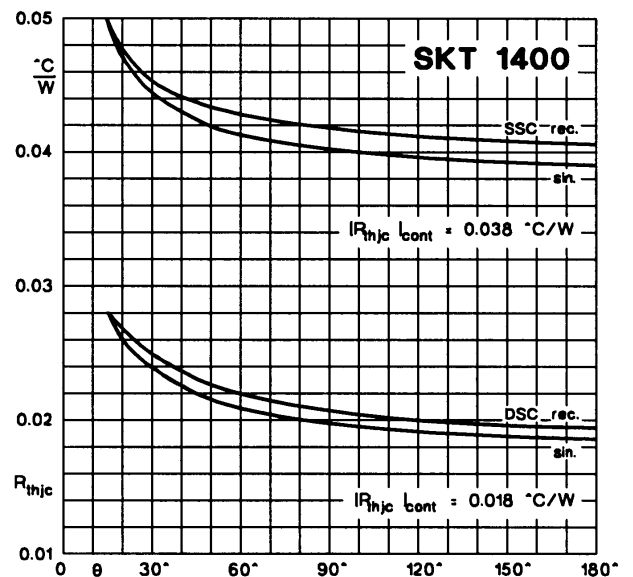

Fig. 5 a Thermal resistance vs. conduction angle

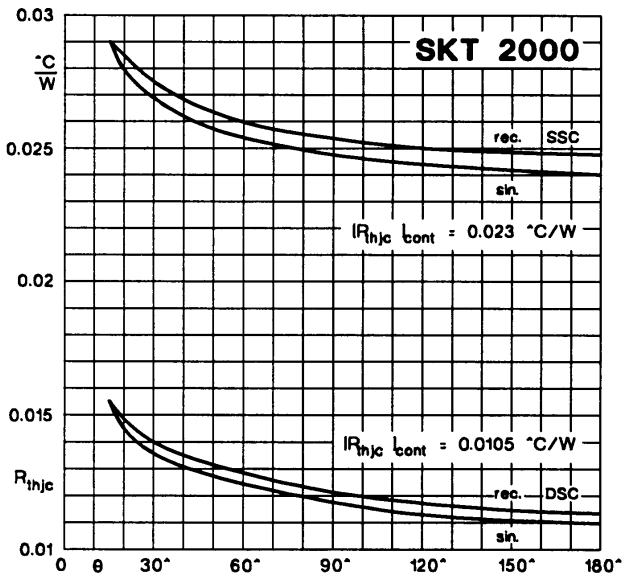

Fig. 5 b Thermal resistance vs. conduction angle

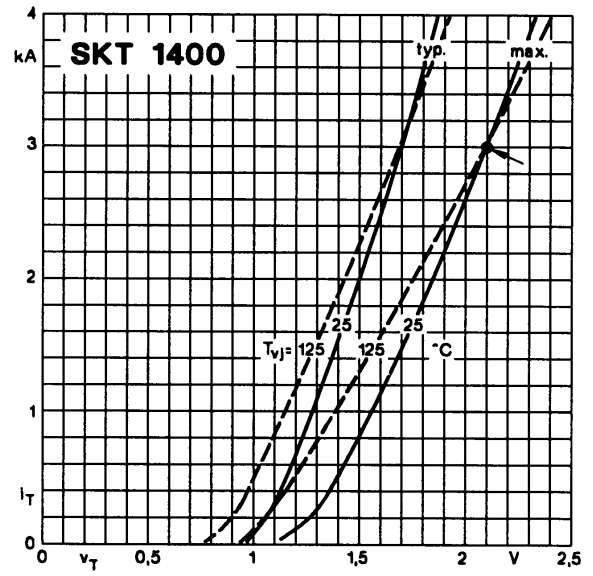

Fig. 6 a On-state characteristics

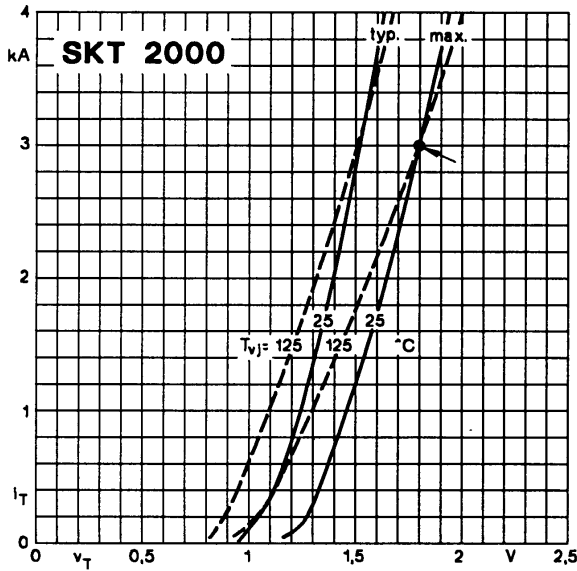

Fig. 6 b On-state characteristics

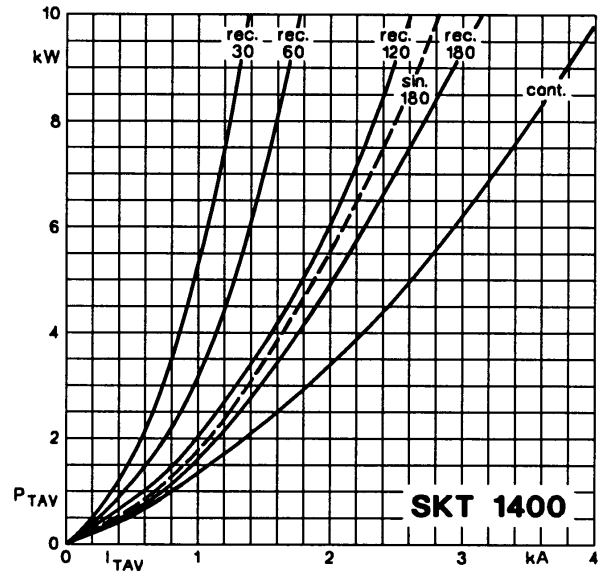

Fig. 7 a Power dissipation vs. on-state current

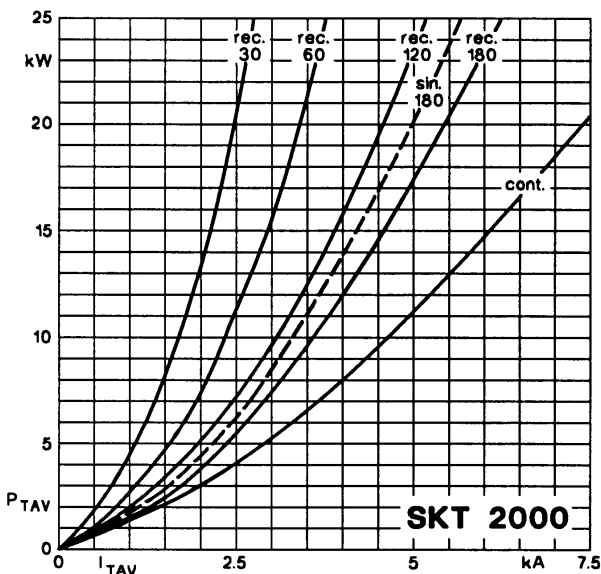

Fig. 7 b Power dissipation vs. on-state current

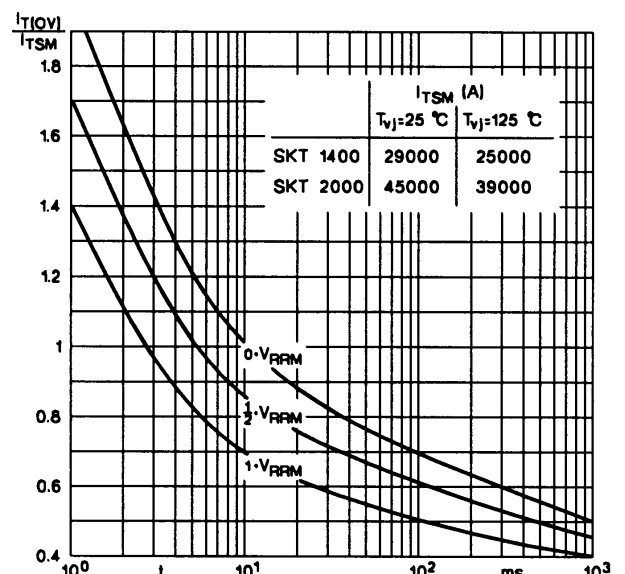

Fig. 8 Surge overload current vs. time

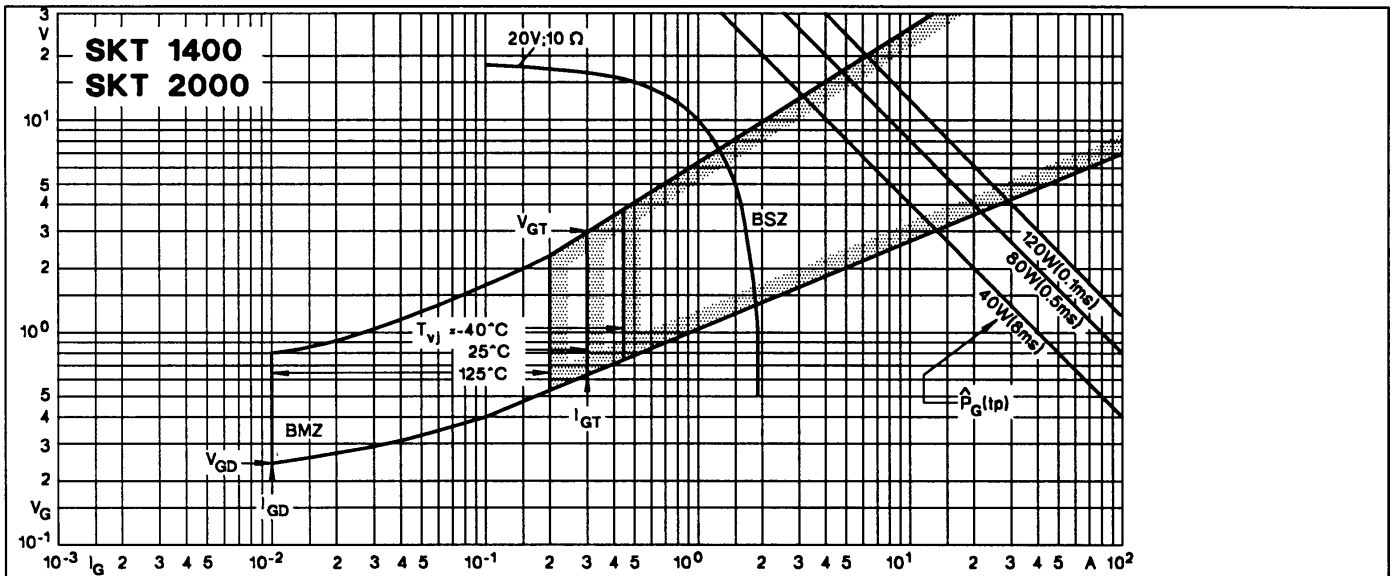
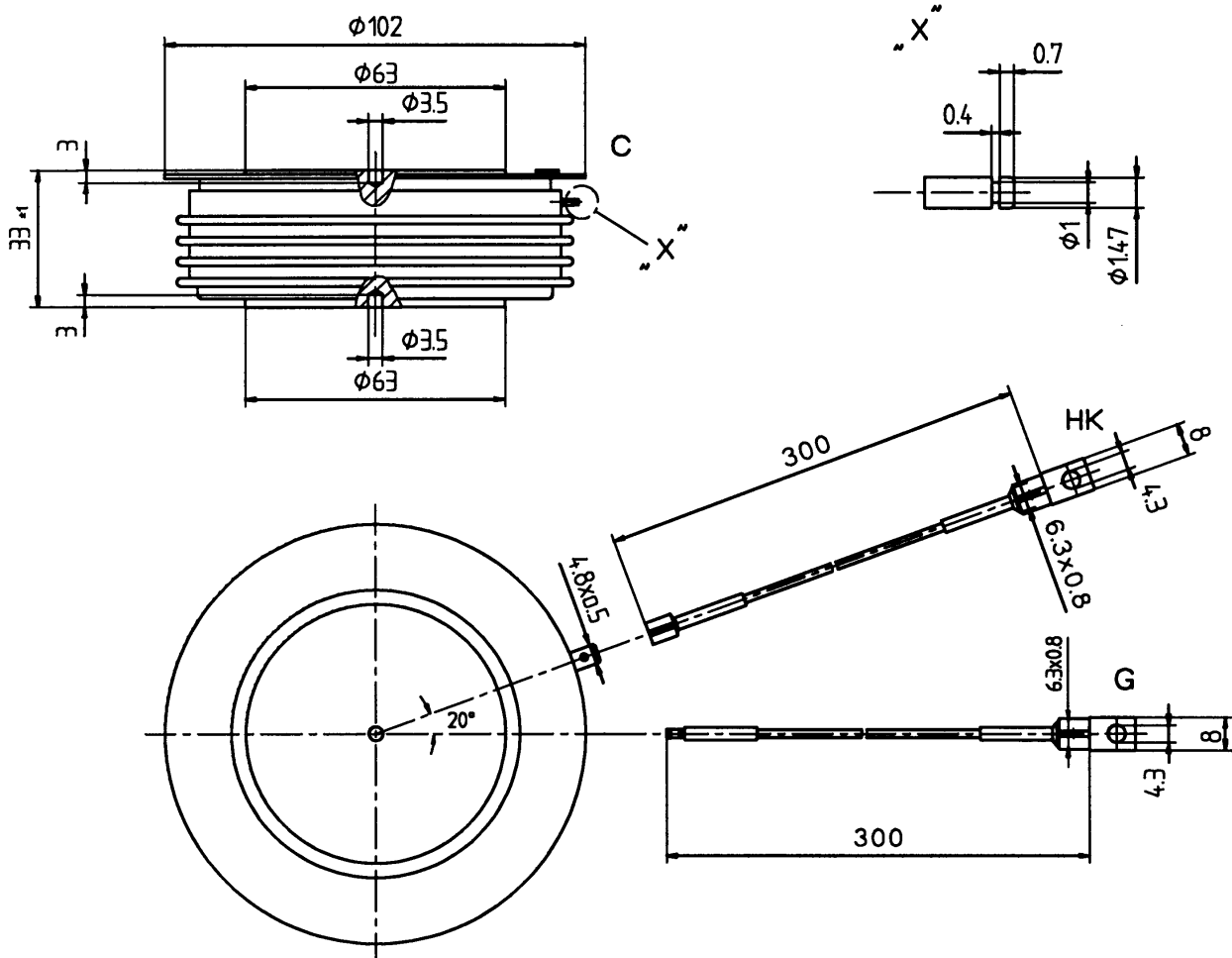

Fig. 9 Gate trigger characteristics

## SKT 1400

Case B 19



- C: Cathode terminal
- A: Anode terminal
- G: Gate terminal (yellow sleeve)
- HK: Auxiliary cathode terminal (red sleeve)

Dimensions in mm

**SKT 2000**

Case B 20

JEDEC: TO-200 AF

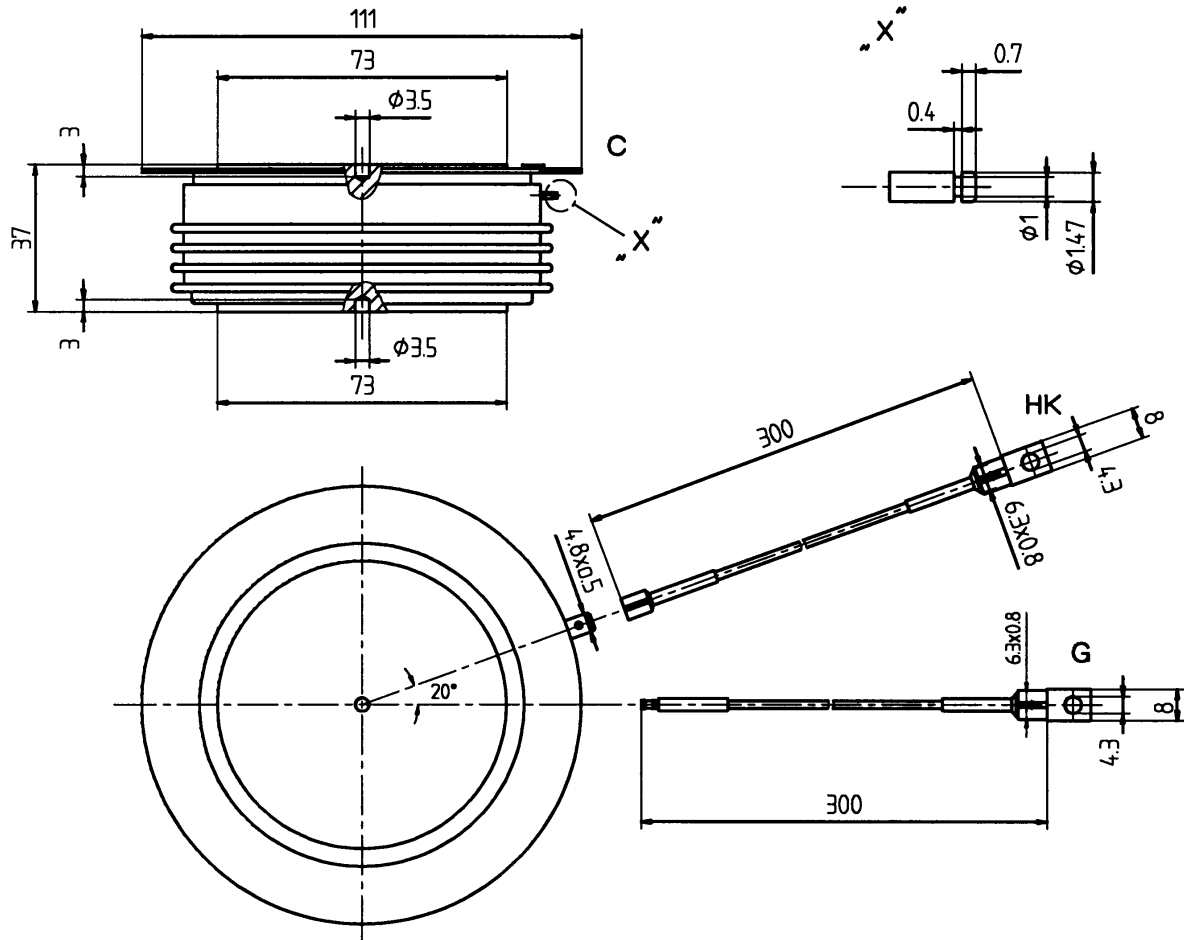

- C: Cathode terminal
- A: Anode terminal
- G: Gate terminal (yellow sleeve)
- HK: Auxiliary cathode terminal (red sleeve)

Dimensions in mm