

Thyristors

SKT 1000 SKT 1200



V _{RSM}	V _{RRM} V _{DRM}	(dv/dt) _{cr}	I _{TRMS} (maximum values for continuous operation)	
			2300 A	2800 A
V	V	V/μs	I _{TAV} (sin. 180; T _{case} = . . . ; DSC)	
			1465 A (58 °C)	1780 A (55 °C)
500	400	500	SKT 1000/04 D	SKT 1200/04 D
900	800	500	SKT 1000/08 E	–
1300	1200	1000	SKT 1000/12 E	SKT 1200/12 E
1500	1400	1000	SKT 1000/14 E	SKT 1200/14 E
1700	1600	1000	SKT 1000/16 E	SKT 1200/16 E
1900	1800	1000	SKT 1000/18 E	SKT 1200/18 E
2300	2200	1000	SKT 1000/22 E L2	–
2700	2600	1000	SKT 1000/26 E L2	–
2900	2800	1000	SKT 1000/28 E L2	–

Symbol	Conditions	SKT 1000	SKT 1200	Units
I _{TAV}	sin. 180; T _{case} = 85 °C; DSC	1000	1200	A
I _{TSM}	T _{vj} = 25 °C; 10 ms	19 000	30 000	A
i ² t	T _{vj} = 125 °C; 10 ms	16 500	25 500	A
	T _{vj} = 25 °C; 8,3 ... 10 ms	1 800	4 500	kA ² s
t _{gd}	T _{vj} = 125 °C; 8,3 ... 10 ms	1 360	3 250	kA ² s
	T _{vj} = 25 °C I _G = 1 A di _G /dt = 1 A/μs		typ. 1	μs
t _{gr}	V _D = 0,67 · V _{DRM}		typ. 2	μs
(di/dt) _{cr}	f = 50 ... 60 Hz		125	A/μs
I _H	T _{vj} = 25 °C; typ./max.	250 / 500		mA
I _L	T _{vj} = 25 °C; R _G = 33 Ω; typ./max.	0,5 / 2		A
t _q	T _{vj} = 125 °C; typ.	100 ... 250		μs
V _T	T _{vj} = 25 °C; I _T = 3600 A; max.	2,0	1,65	V
V _{T(TO)}	T _{vj} = 125 °C	1,14	0,95	V
r _T	T _{vj} = 125 °C	0,243	0,18	mΩ
I _{DD} ; I _{RD}	T _{vj} = 125 °C; V _{RD} = V _{RRM} V _{DD} = V _{DRM}		100	mA
V _{GT}	T _{vj} = 25 °C		5	V
I _{GT}	T _{vj} = 25 °C		250	mA
V _{GD}	T _{vj} = 125 °C		0,25	V
I _{GD}	T _{vj} = 125 °C		10	mA
R _{thjc}	cont.;	0,021		°C/W
R _{thch}	sin. 180; DSC/SSC	0,0225 / 0,054		°C/W
	rec. 120; DSC/SSC	0,027 / 0,060		°C/W
	DSC/SSC	0,005 / 0,010		°C/W
T _{vj}		– 40 ... + 125		°C
T _{stg}		– 40 ... + 130		°C
F	SI units	22 ... 25		kN
w	US units	5000 ... 5600		lbs.
		550		g
Case		B 14		

Features

- Hermetic metal cases with ceramic insulators
- Capsule packages for double sided cooling
- International standard cases
- Off-state and reverse voltages up to 2800 V
- Amplifying gate

Typical Applications

- DC motor control (e. g. for machine tools)
- Controlled rectifiers (e. g. for battery charging)
- AC controllers (e. g. for temperature control)

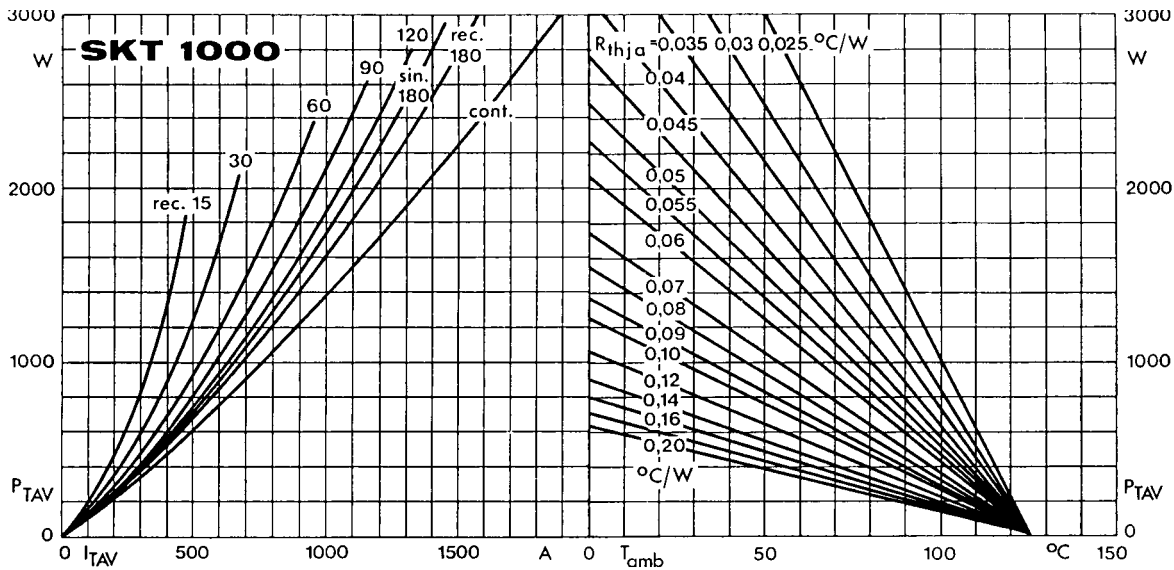

Fig. 1 a Power dissipation vs. on-state current and ambient temperature

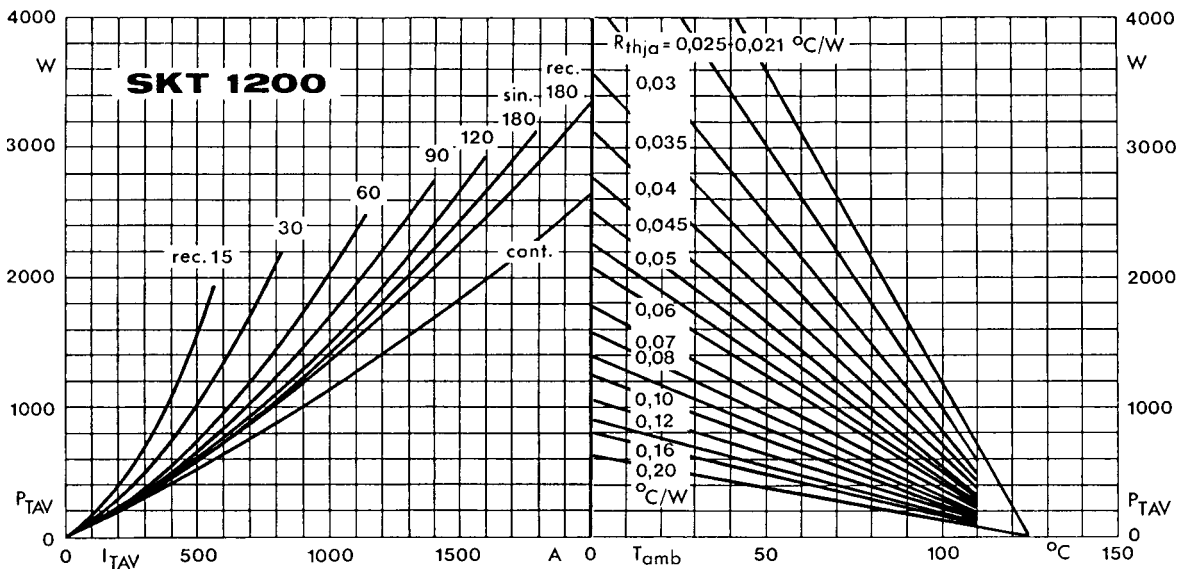

Fig. 1 b Power dissipation vs. on-state current and ambient temperature

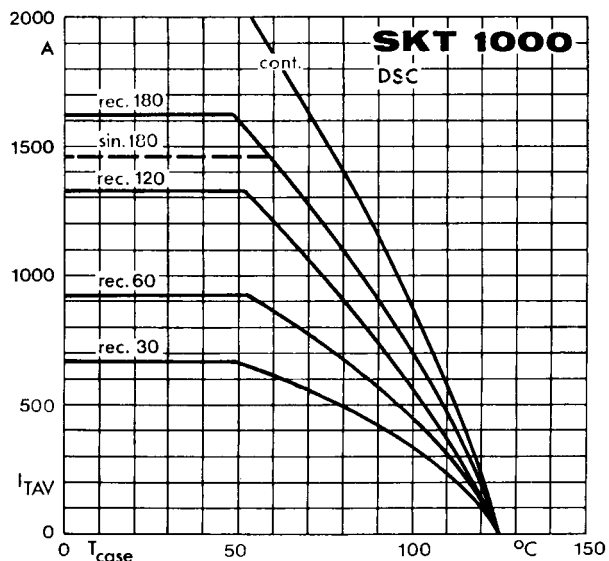

Fig. 2 a Rated on-state current vs. case temperature

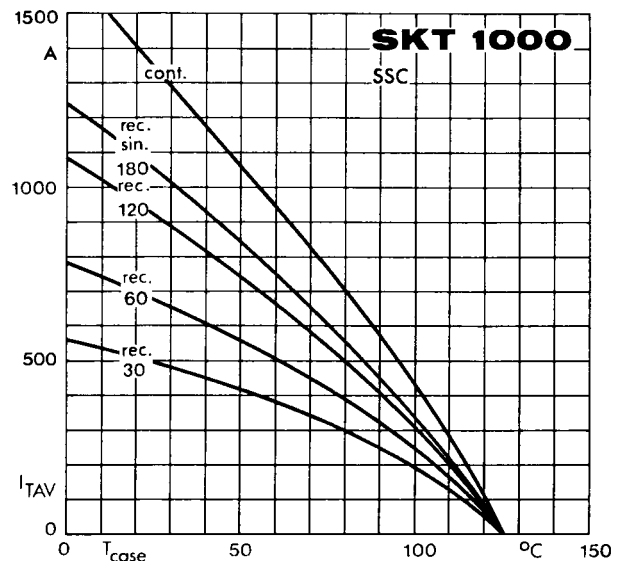

Fig. 2 b Rated on-state current vs. case temperature

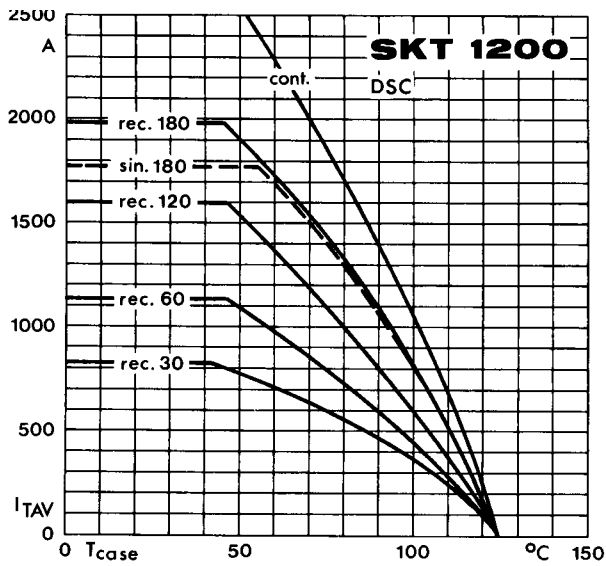

Fig. 2 c Rated on-state current vs. case temperature

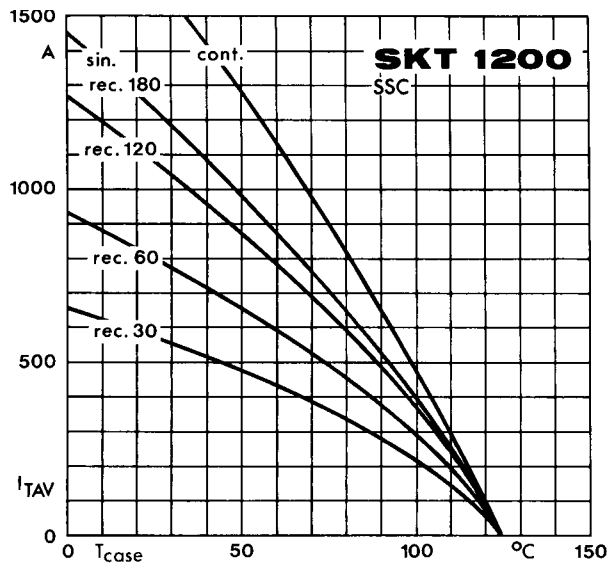

Fig. 2 d Rated on-state current vs. case temperature

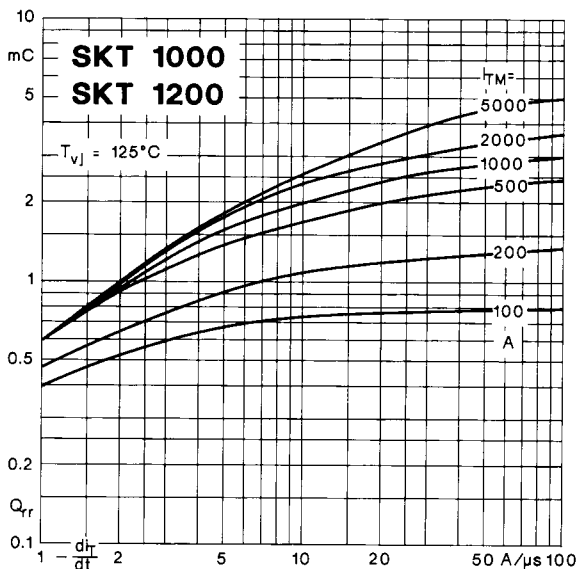

Fig. 3 Recovered charge vs. current decrease

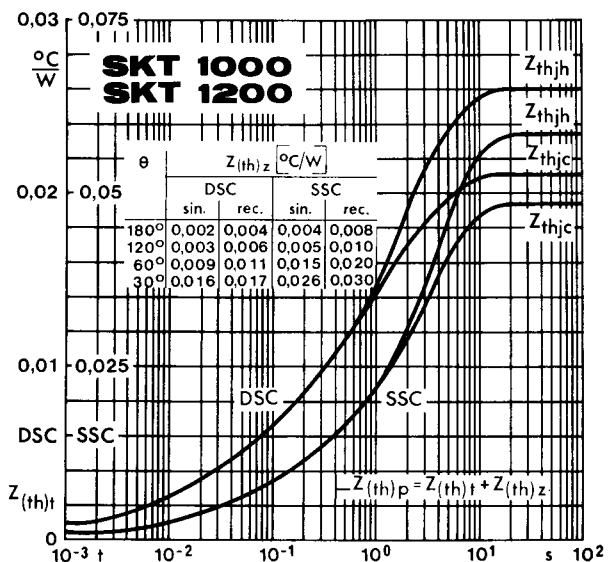

Fig. 4 Transient thermal impedance vs. time

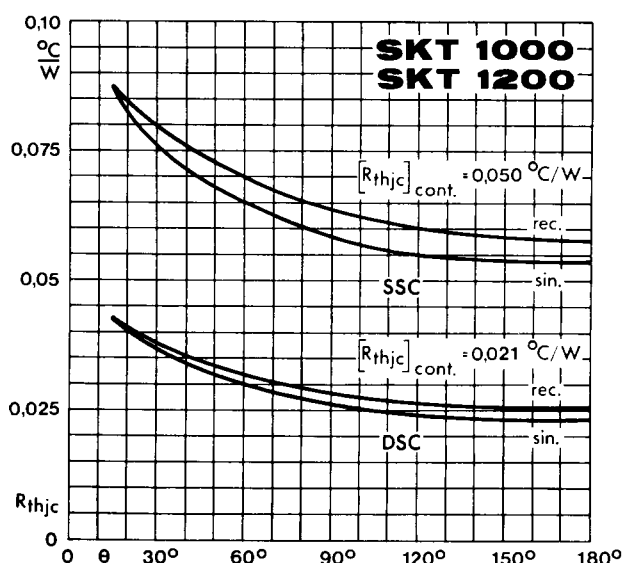

Fig. 5 Thermal resistance vs. conduction angle

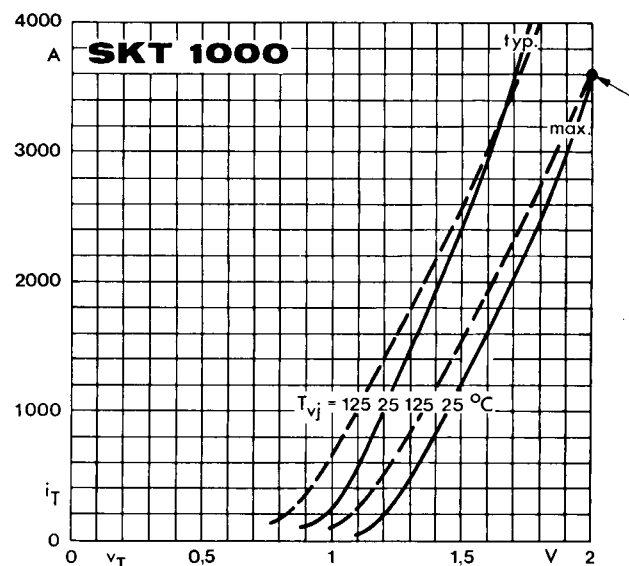

Fig. 6 a On-state characteristics

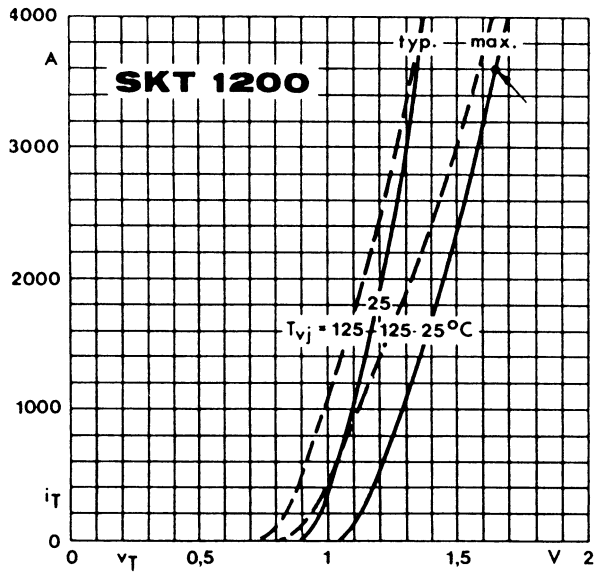

Fig. 6 b On-state characteristics

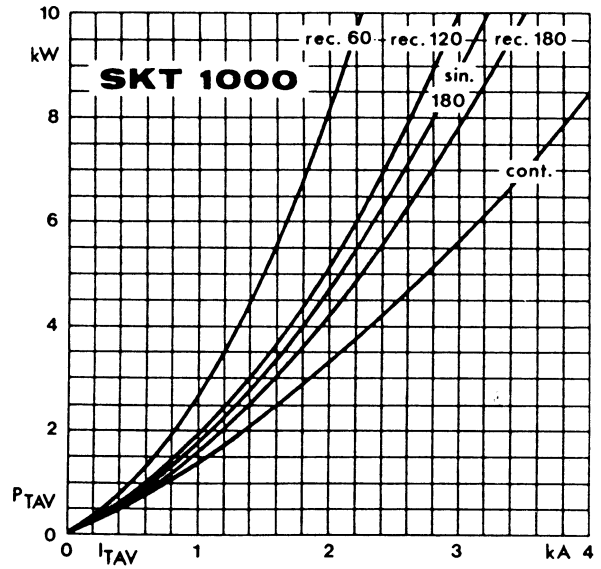

Fig. 7 a Power dissipation vs. on-state current

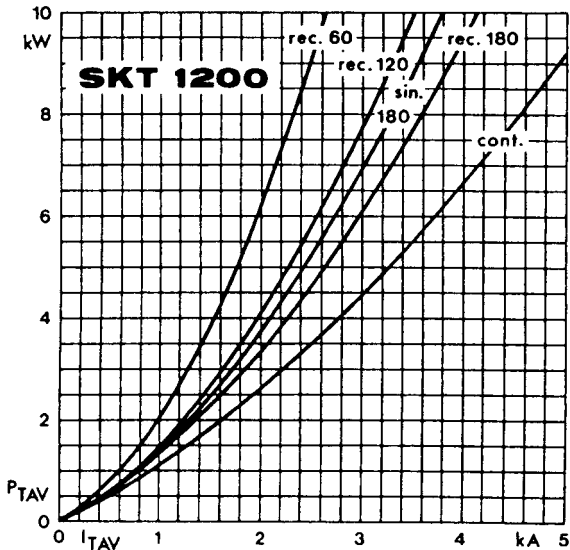

Fig. 7 b Power dissipation vs. on-state current

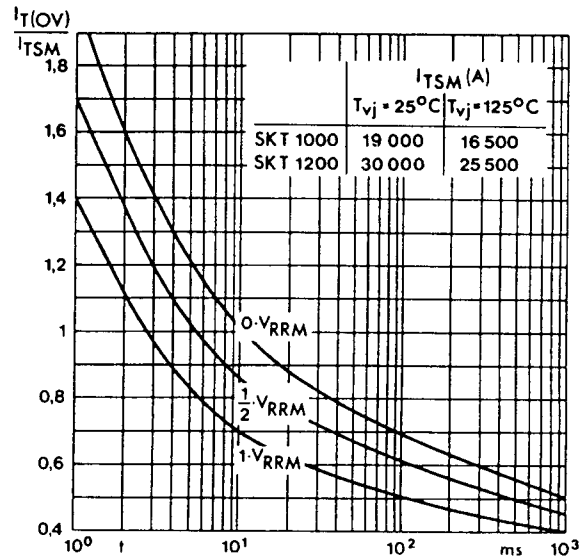

Fig. 8 Surge overload current vs. time

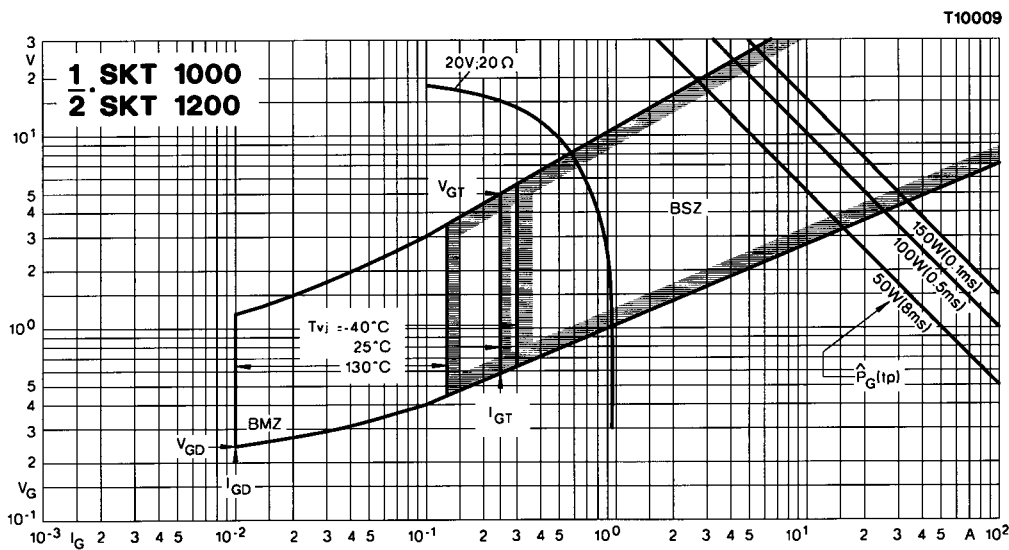
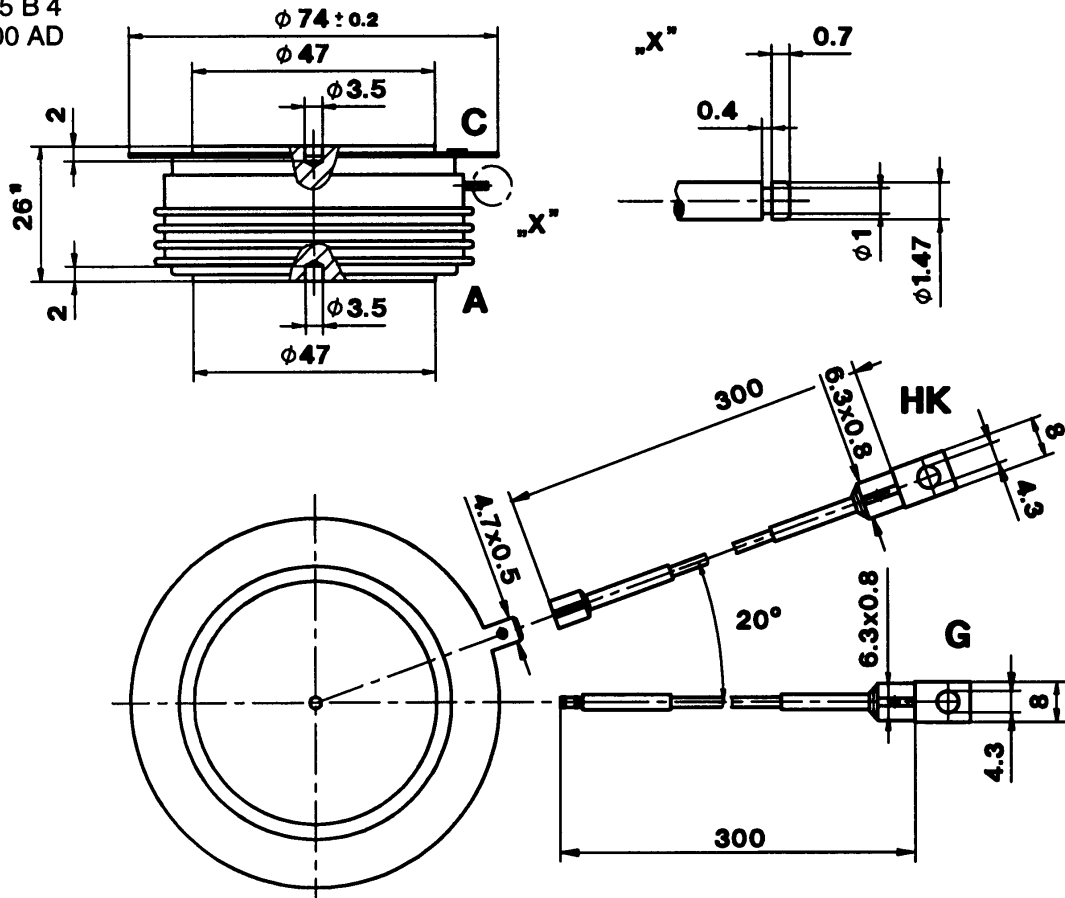

Fig. 9 Gate trigger characteristics

SKT 1000
SKT 1200

Case B 14

DIN 41814: 155 B 4
JEDEC: TO-200 AD



1) SKT 1000/... L 2: 27,5 mm

- C: Cathode terminal
- A: Anode terminal
- G: Gate terminal (yellow sleeve)
- HK: Auxiliary cathode terminal (red sleeve)

Dimensions in mm