

SEMIPACK® 2 Fast Diode¹⁾ Modules

SKKD 75 F

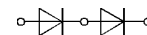

SKKD

Features

- Soft recovery
- Very short recovery times
- Low switching losses
- Up to 1200 V peak inverse voltage
- Heat transfer through ceramic isolated metal baseplate
- UL recognized, file no. E 63 532

Typical Applications

- Self-commutated inverters
- DC choppers
- AC motor speed control
- Inductive heating
- Uninterruptible power supplies
- Electronic welders
- General power switching applications

V_{RSM} V_{RRM}	I_{FRMS} (maximum values for continuous operation) 110 A
V	I_{FAV} (sin. 180; $T_{case} = 85\text{ °C}$; 50 Hz) 58 A
1100	SKKD 75 F 11
1200	SKKD 75 F 12

Symbol	Conditions	SKKD 75 F	Units	
I_{FAV}	sin. 180; $T_{case} = 65\text{ °C}$	70	A	
I_{FSM}	$T_{vj} = 25\text{ °C}$; 10 ms	1 000	A	
	$T_{vj} = 150\text{ °C}$; 10 ms	900	A	
i^2t	$T_{vj} = 25\text{ °C}$; 8,3 ... 10 ms	5 000	$A^2\text{ s}$	
	$T_{vj} = 150\text{ °C}$; 8,3 ... 10 ms	4 000	$A^2\text{ s}$	
I_{RM}	$T_{vj} = 25\text{ °C}$ $\left\{ \begin{array}{l} I_F = 75\text{ A} \\ di/dt = 500\text{ A}/\mu\text{s} \\ V_R = 600\text{ V} \end{array} \right.$	30	A	
		50	A	
t_{rr}	$T_{vj} = 25\text{ °C}$	typ. 150	ns	
Q_{rr}	$T_{vj} = 150\text{ °C}$	23	μC	
I_R	$T_{vj} = 25\text{ °C}$; $V_R = V_{RRM}$	0,4	mA	
	$T_{vj} = 150\text{ °C}$; $V_R = V_{RRM}$	20	mA	
V_F	$T_{vj} = 25\text{ °C}$; $I_F = 75\text{ A}$	2,2	V	
	$T_{vj} = 150\text{ °C}$; $I_F = 75\text{ A}$	2,0	V	
$V_{(TO)}$	$T_{vj} = 150\text{ °C}$	1,2	V	
r_T	$T_{vj} = 150\text{ °C}$	11	$\text{m}\Omega$	
R_{thjc}	per diode / per module	0,4/0,2	$^{\circ}\text{C}/\text{W}$	
R_{thch}	per diode / per module	0,1/0,05	$^{\circ}\text{C}/\text{W}$	
T_{vj}		- 40 ... +150	$^{\circ}\text{C}$	
T_{stg}		- 40 ... +150	$^{\circ}\text{C}$	
V_{isol}	a. c. 50 Hz; r.m.s.; 1 min	4000	V~	
M_1	to heatsink	SI units	$5 \pm 15\%$	Nm
		US units	$44 \pm 15\%$	lb. in
M_2	for terminals	SI units	$5 \pm 15\%$	Nm
		US units	$44 \pm 15\%$	lb. in
w	approx.	250	g	
Case	→ page B 2 – 28	A 23		

¹⁾ CAL (controlled axial lifetime) technology, patent No. DE 43 10 44

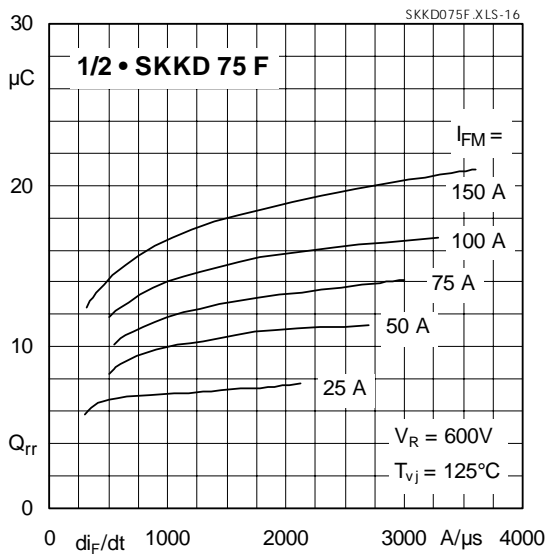

Fig. 16 Typ. recovered charge vs. current decrease

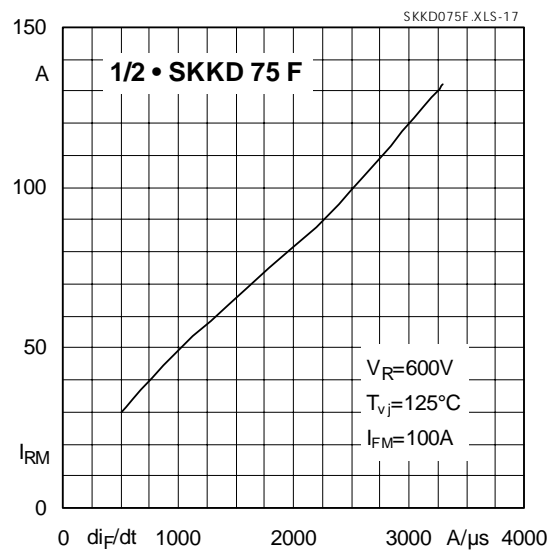

Fig. 17 Typ. peak recovery current vs. current decrease

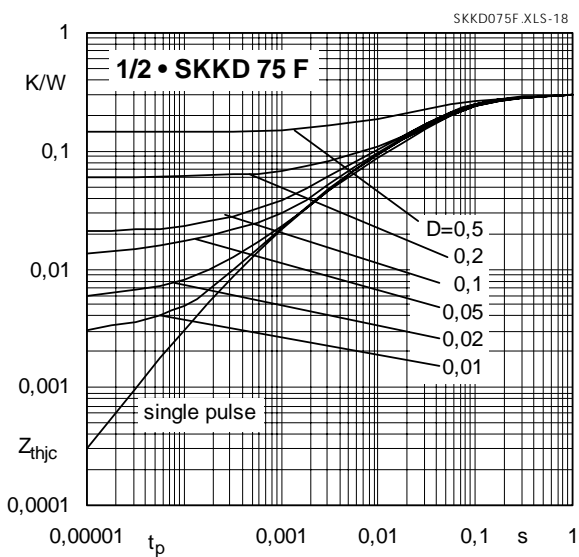

Fig. 18 Typ. transient thermal impedances vs. time

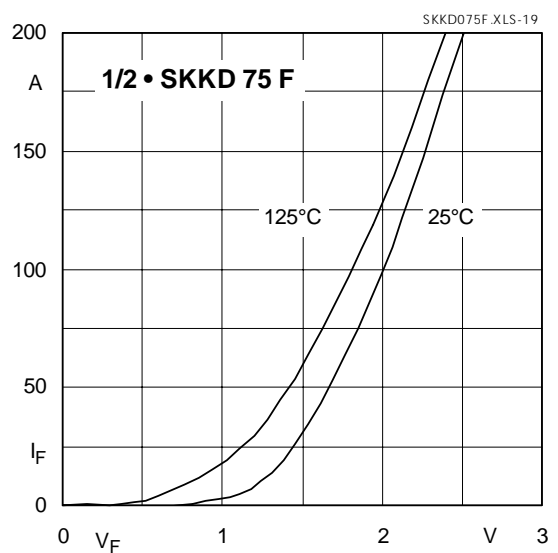

Fig. 19 Typ. forward characteristics

SKKD 105 F, 115 F

Case A 10

IEC 192-2: A 77 A
JEDEC: TO-240 AA

SEMIPACK® 1

UL recognized, file no. E 63 532

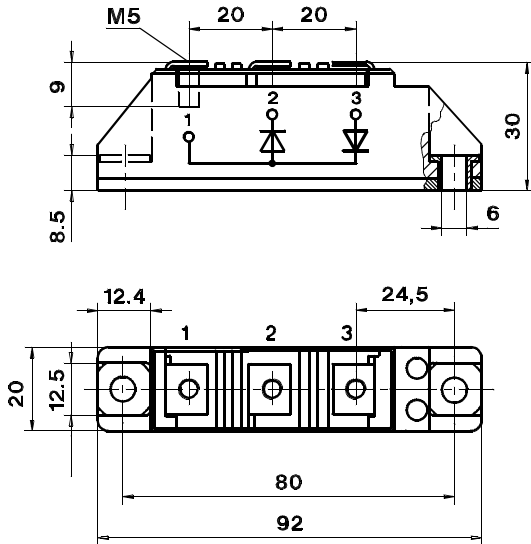
**SKKD 60 F, 75 F**

Case A 23

SEMIPACK® 2

UL recognized, file no. E 63 532

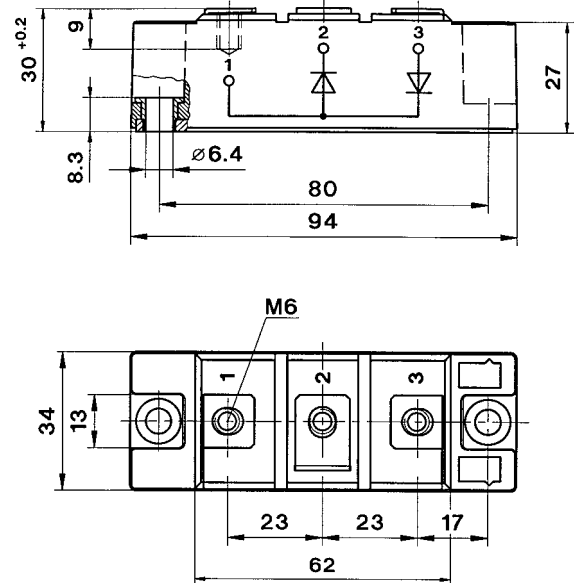
**SKMD 105 F**

Case A 33

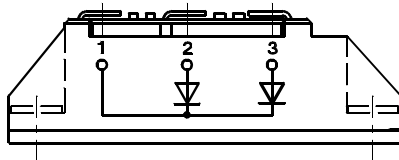
**SKMD 150 F, 202 E**

Case A 51

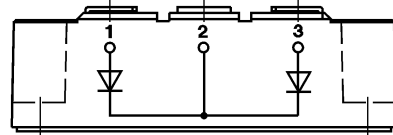
**SKND 105 F**

Case A 37

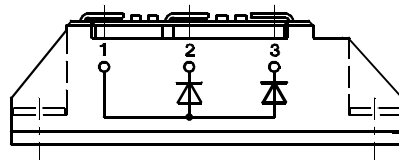

Dimensions in mm

SKND 150 F, 202 E

Case A 52

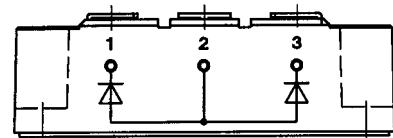
**SKKD 150 F, 170 F**

Case A 53

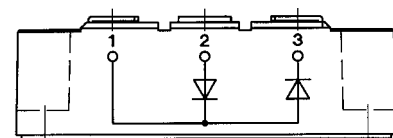

Dimensions in mm