

## Antiparallel Thyristors with Isolated Water Flow

**SKIW 700**  
**SKIW 900**

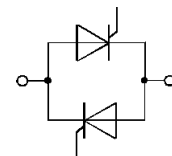

### Features

- Compact units containing two high current thyristors connected in antiparallel
- Internal insulation between thyristors and cooling media via aluminium oxyde (AlO<sub>2</sub>)
- All plastic material used carries Underwriters Laboratories flammability classification 94V-0

### Typical Applications

- Large resistance welding equipment
- Large electroplating equipment

$V_{DRM}$ $V_{RSM}$ $V_{RRM}$ V	$I_{RMS}^{1)}$ ( $Vol_w = 4$ l/min., $T_w = 40$ °C, ED = 50 %, n = 10)	
	850 A	1200 A
1200	<b>SKIW 700/12</b>	<b>SKIW 900/12</b>
1400	<b>SKIW 700/14</b>	<b>SKIW 900/14</b>
1600	<b>SKIW 700/16</b>	<b>SKIW 900/16</b>

Symbol	Conditions	SKIW 700	SKIW 900
$I_{RMS}^{1)}$	$Vol_w = 4$ l/min, $T_w = 40$ °C, ED = 100 %	700 A	900 A
$I_{TSM}$	$T_{vj} = 40$ °C; 10 ms $T_{vj} = 125$ °C; 10 ms	7 000 A 6 000 A	10 000 A 8 500 A
$i^2t$	$T_{vj} = 40$ °C; 8,3 ... 10 ms $T_{vj} = 125$ °C; 8,3 ... 10 ms	245 000 A <sup>2</sup> s 180 000 A <sup>2</sup> s	500 000 A <sup>2</sup> s 360 000 A <sup>2</sup> s
$(di/dt)_{cr}$ $(dv/dt)_{cr}$	f = 50 ... 60 Hz $T_{vj} = 125$ °C	125 A/μs 200 V/μs	
$t_q$	$T_{vj} = 125$ °C; typ.	150 μs	
$I_H$	$T_{vj} = 25$ °C	200 mA	
$I_L$	$T_{vj} = 25$ °C; $R_G = 33$ Ω	600 mA	
$V_T$	$T_{vj} = 25$ °C; ( $I_T = \dots$ ); max.	1,65 V (500 A)	1,45 V (800 A)
$V_{T(TO)}$	$T_{vj} = 125$ °C	1,0 V	1,0 V
$r_T$	$T_{vj} = 125$ °C	0,7 mΩ	0,5 mΩ
$V_{GT}$	$T_{vj} = 25$ °C	3 V	
$I_{GT}$	$T_{vj} = 25$ °C	200 mA	
$V_{GD}$	$T_{vj} = 125$ °C	0,25 V	
$I_{GD}$	$T_{vj} = 125$ °C	10 mA	
$R_{thjw}$	$Vol_w = 4$ l/min	0,175 °C/W	0,14 °C/W
$T_{vj}$	max.	125 °C	
$T_{stg}$	min. ... max.	5 ... 85 °C	
$V_{ISOL}$	a.c. 50 Hz; r.m.s.; 1 min	2500 V~	
$M_2$	SI units / US units	20 Nm / 180 lb. in.	
$p_w$	max.	10 bar	
w		1,3 kg	
Case		C 1	

<sup>1)</sup> For  $Vol_w = 2$  l/min and  $T_w = 30$  °C the same  $I_{RMS}$  values apply

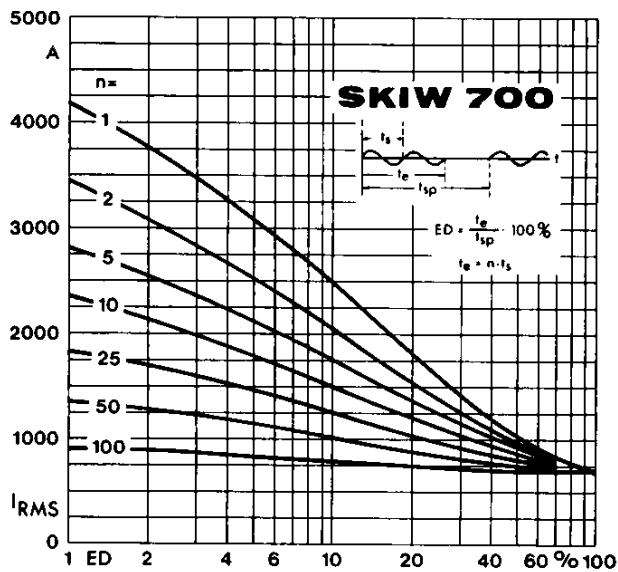

Fig. 1 a Rated rms current vs. duty cycle

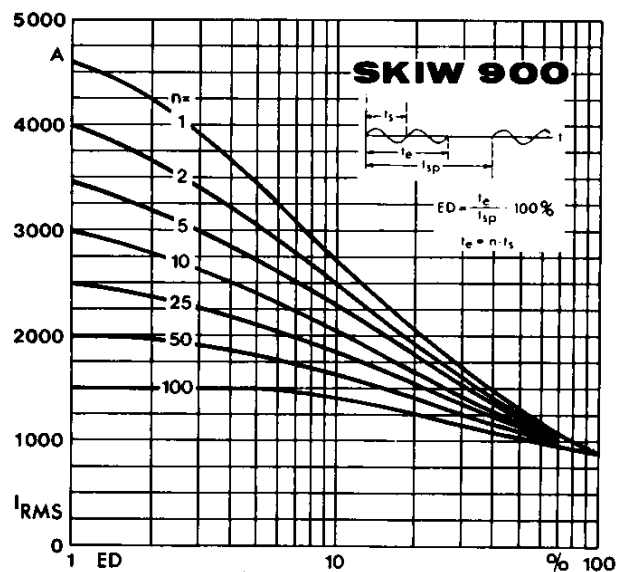

Fig. 1 b Rated rms current vs. duty cycle

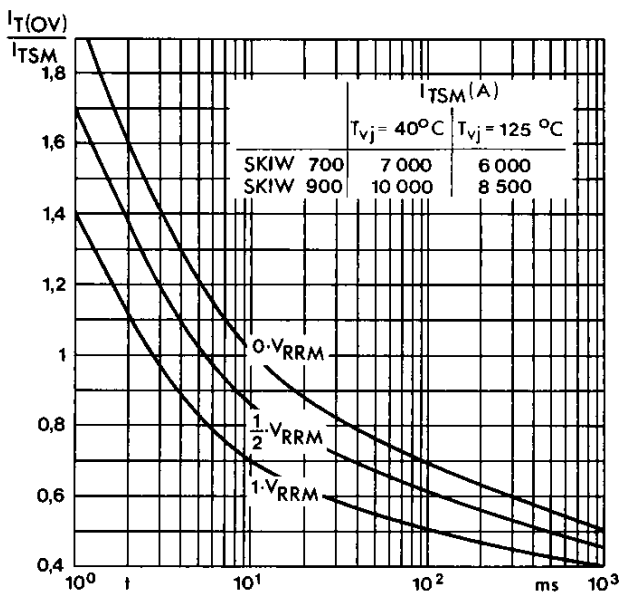

Fig. 2 Surge overload current vs. time

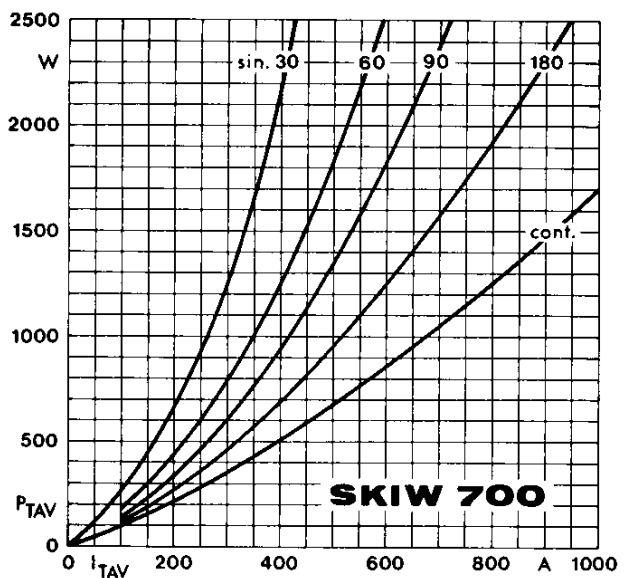

Fig. 3 a Power dissipation vs. mean on-state current

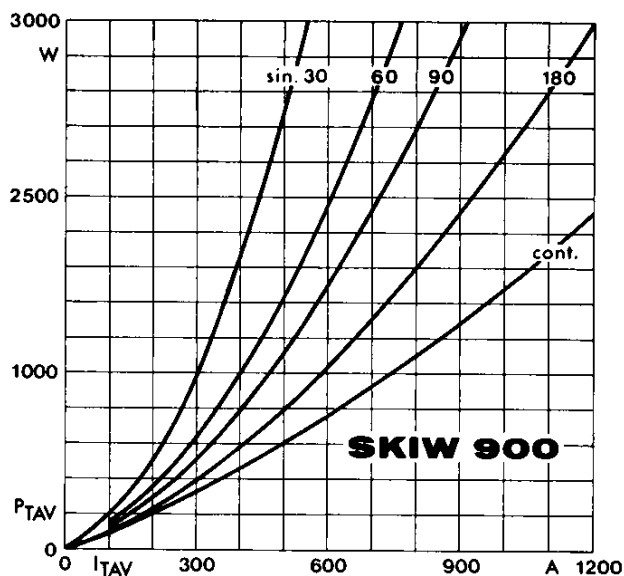

Fig. 3 b Power dissipation vs. mean on-state current

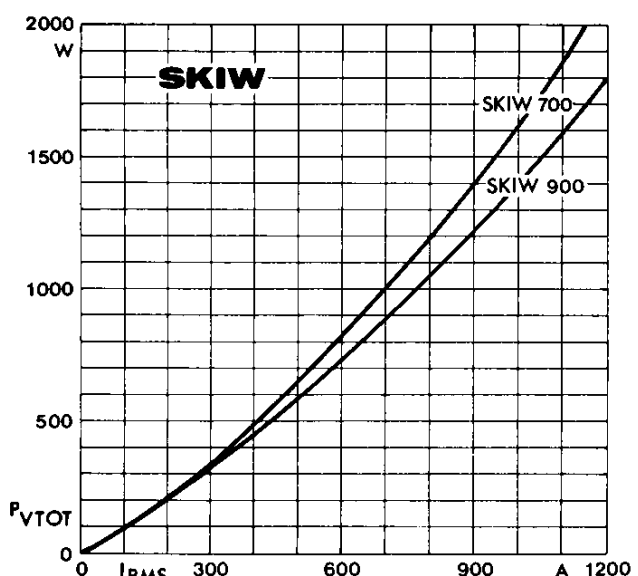

Fig. 4 Power dissipation vs. rms on-state current

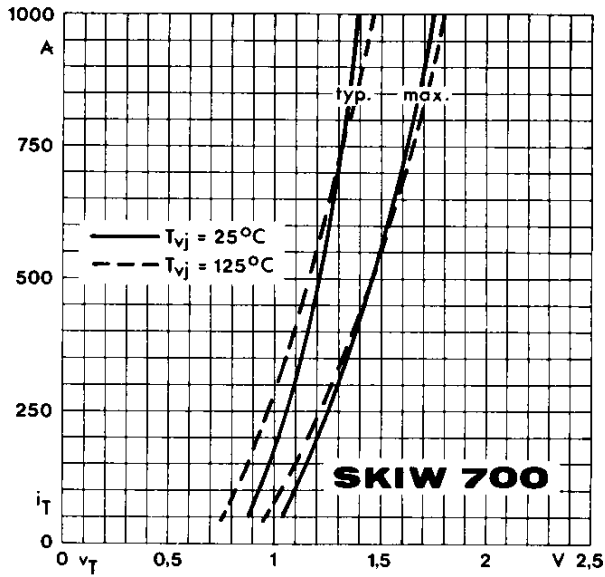

Fig. 5 a On-state characteristics

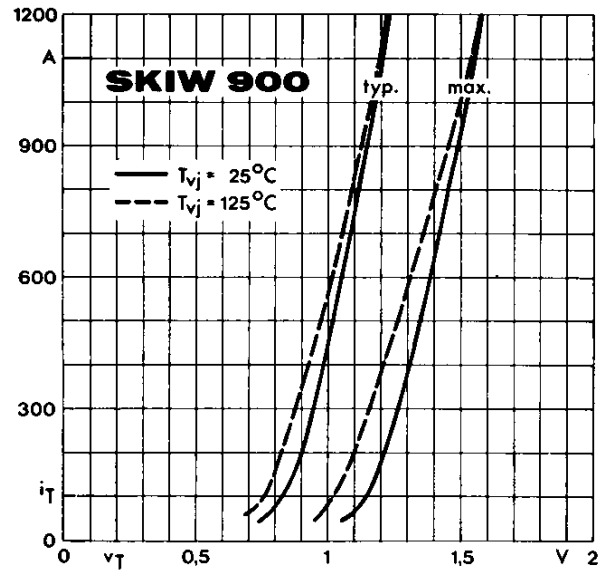

Fig. 5 b On-state characteristics

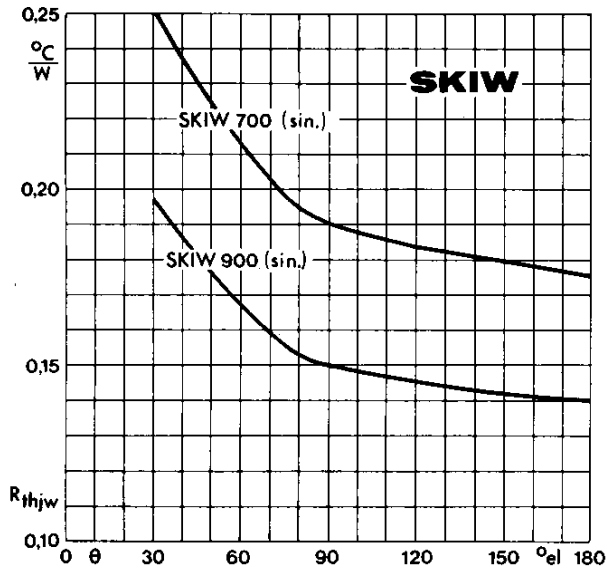

Fig. 6 Thermal resistance vs. conduction angle

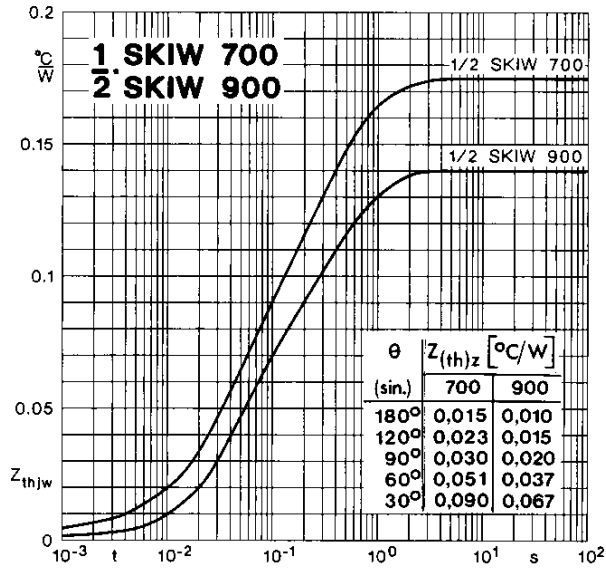

Fig. 7 Transient thermal impedance vs. time

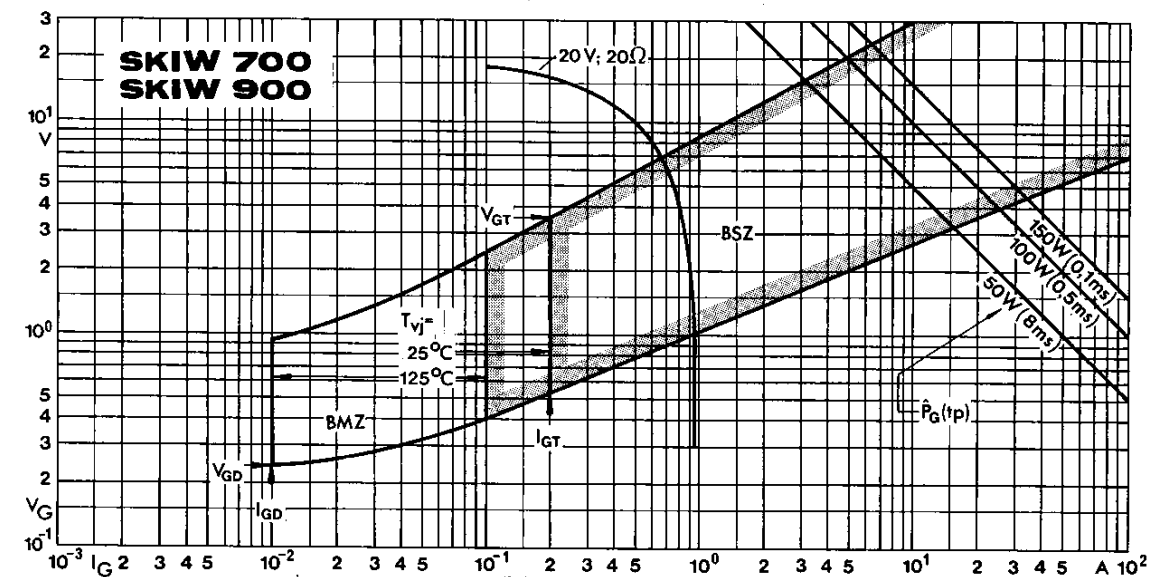
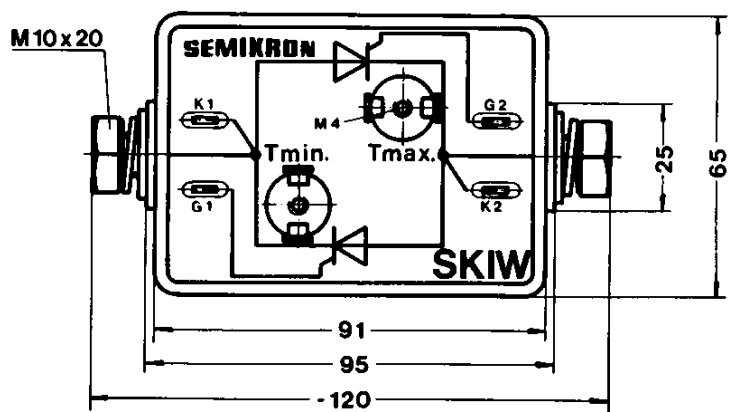
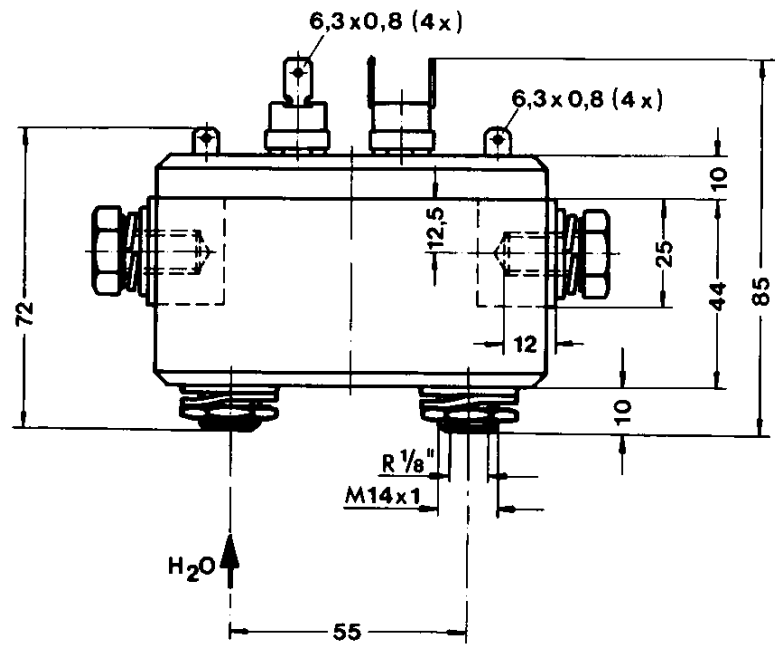

Fig. 8 Gate trigger characteristics

SKIW 700  
 SKIW 900  
 Case C 1



Dimensions in mm