

Antiparallel Thyristors with Isolated Water Flow

SKIW 250 SKIW 500

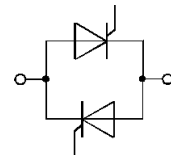

Features

- Compact units containing two high current thyristors connected in antiparallel
- Internal insulation between thyristors and cooling media via aluminium oxyde (Al_2O_3)
- All plastic material used carries Underwriters Laboratories flammability classification 94V-0

Typical Applications

- Large resistance welding equipment
- Large electroplating equipment

V_{DRM} V_{RSM} V_{RRM} V	$I_{RMS}^{1)}$ ($Vol_w = 4$ l/min., $T_w = 40$ °C, ED = 50 %, n = 10)	
	280 A	580 A
1200	SKIW 250/12	SKIW 500/12
1400	SKIW 250/14	SKIW 500/14
1600	SKIW 250/16	SKIW 500/16

Symbol	Conditions	SKIW 250	SKIW 500
$I_{RMS}^{1)}$	$Vol_w = 4$ l/min, $T_w = 40$ °C, ED = 100 %	250 A	500 A
I_{TSM}	$T_{vj} = 40$ °C; 10 ms	1700 A	4000 A
	$T_{vj} = 125$ °C; 10 ms	1500 A	3400 A
i^2t	$T_{vj} = 40$ °C; 8,3 ... 10 ms	14 500 A ² s	80 000 A ² s
	$T_{vj} = 125$ °C; 8,3 ... 10 ms	11 000 A ² s	58 000 A ² s
$(di/dt)_{cr}$	f = 50 ... 60 Hz	125 A/ μ s	
$(dv/dt)_{cr}$	$T_{vj} = 125$ °C	200 V/ μ s	
t_q	$T_{vj} = 125$ °C; typ.	150 μ s	
I_H	$T_{vj} = 25$ °C	200 mA	
I_L	$T_{vj} = 25$ °C; $R_G = 33$ Ω	600 mA	
V_T	$T_{vj} = 25$ °C; ($I_T = \dots$); max.	2,25 V (300 A)	1,75 V (500 A)
$V_{T(TO)}$	$T_{vj} = 125$ °C	1,2 V	1,0 V
r_T	$T_{vj} = 125$ °C	4 m Ω	1,5 m Ω
V_{GT}	$T_{vj} = 25$ °C	3 V	
I_{GT}	$T_{vj} = 25$ °C	200 mA	
V_{GD}	$T_{vj} = 125$ °C	0,25 V	
I_{GD}	$T_{vj} = 125$ °C	10 mA	
R_{thjw}	$Vol_w = 4$ l/min	0,35 °C/W	0,20 °C/W
T_{vj}	max.	125 °C	
T_{stg}	min. ... max.	5 ... 85 °C	
V_{ISOL}	a.c. 50 Hz; r.m.s.; 1 min	2500 V~	
M_2	SI units / US units	20 Nm / 180 lb. in.	
p_w	max.	10 bar	
w		1,3 kg	
Case		C 1	

¹⁾ For $Vol_w = 2$ l/min and $T_w = 30$ °C the same I_{RMS} values apply

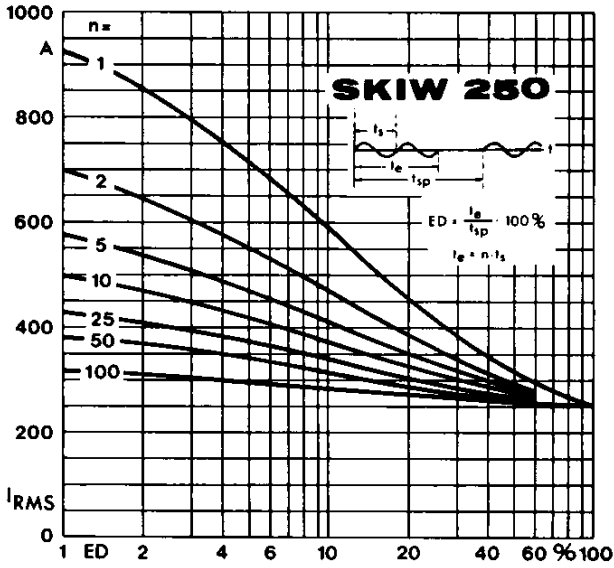

Fig. 1 a Rated rms current vs. duty cycle

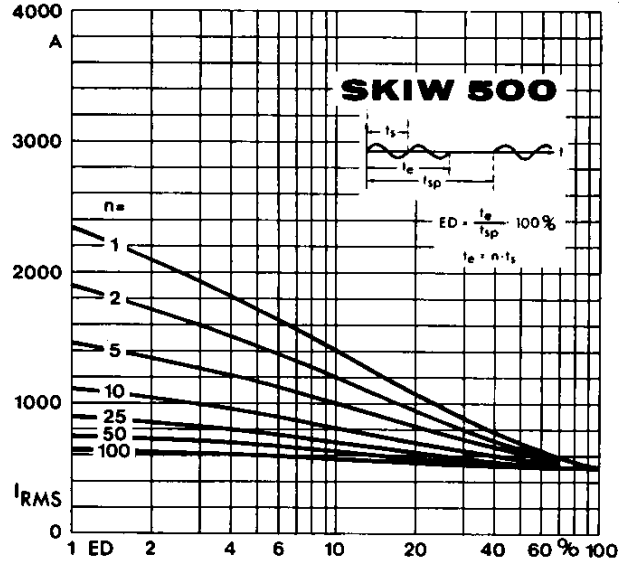

Fig. 1 b Rated rms current vs. duty cycle

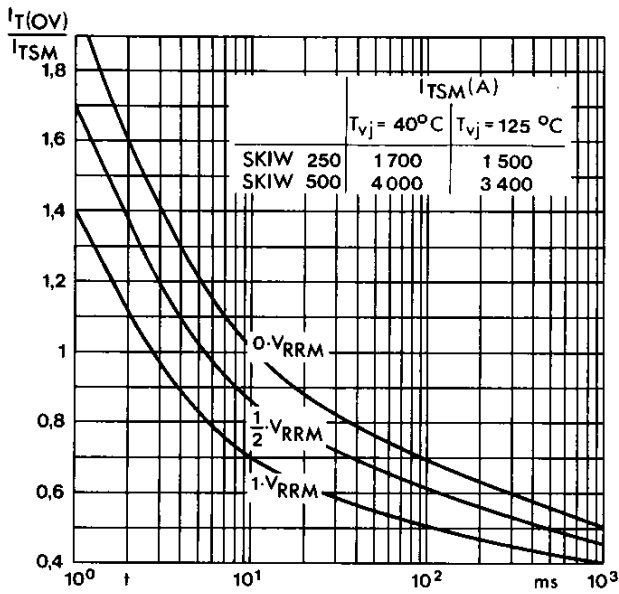

Fig. 2 Surge overload current vs. time

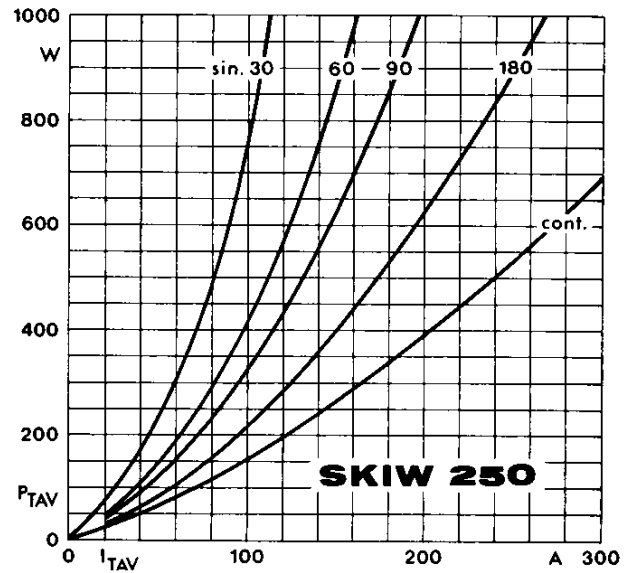

Fig. 3 a Power dissipation vs. mean on-state current

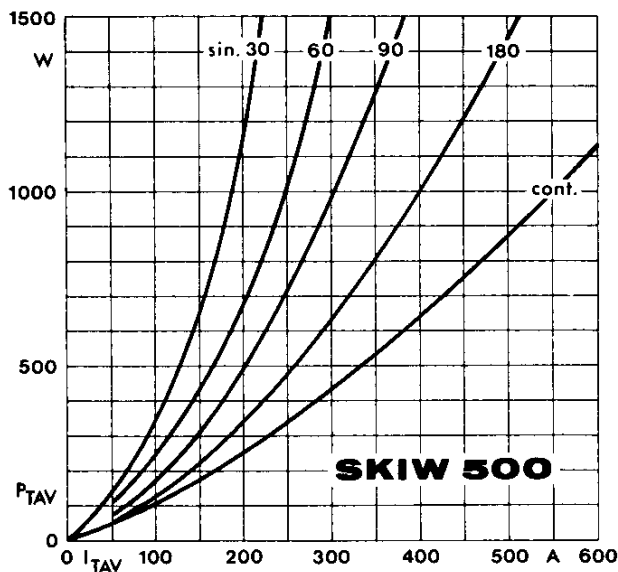

Fig. 3 b Power dissipation vs. mean on-state current

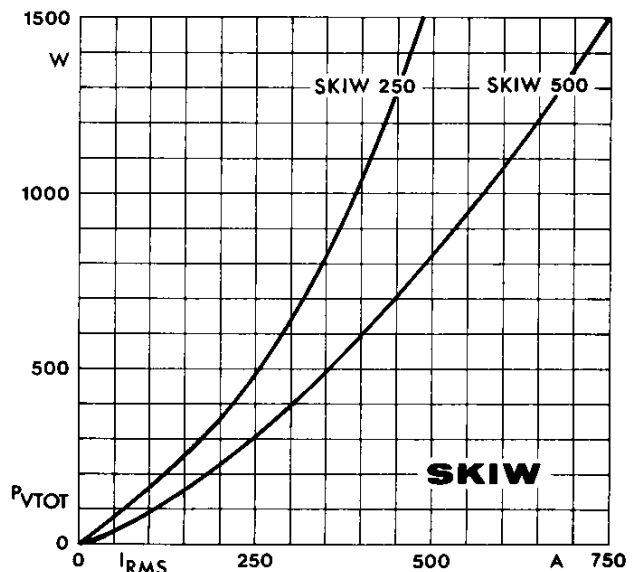

Fig. 4 Power dissipation vs. rms on-state current

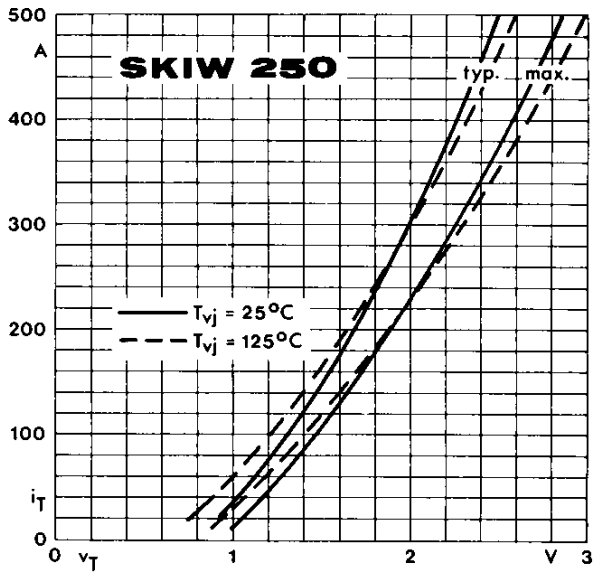

Fig. 5 a On-state characteristics

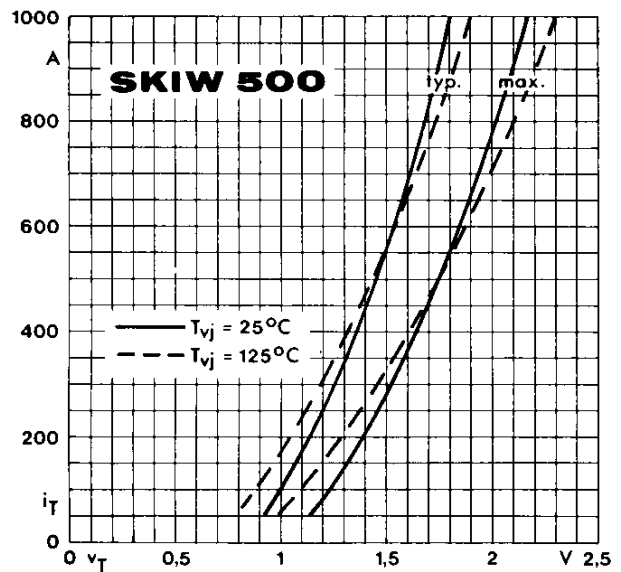

Fig. 5 b On-state characteristics

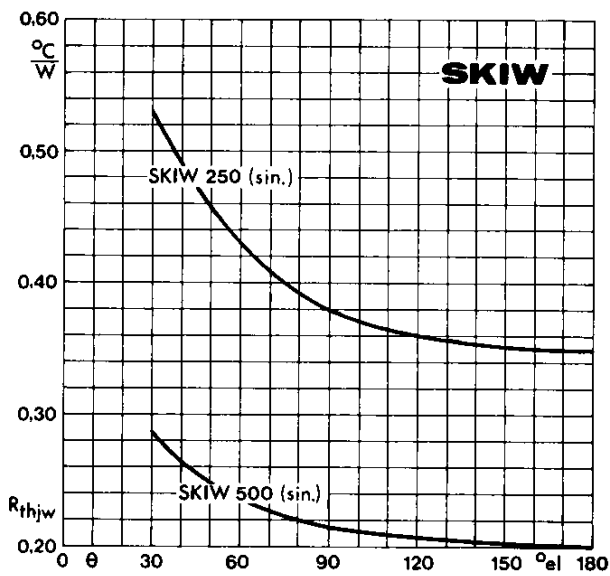

Fig. 6 Thermal resistance vs. conduction angle

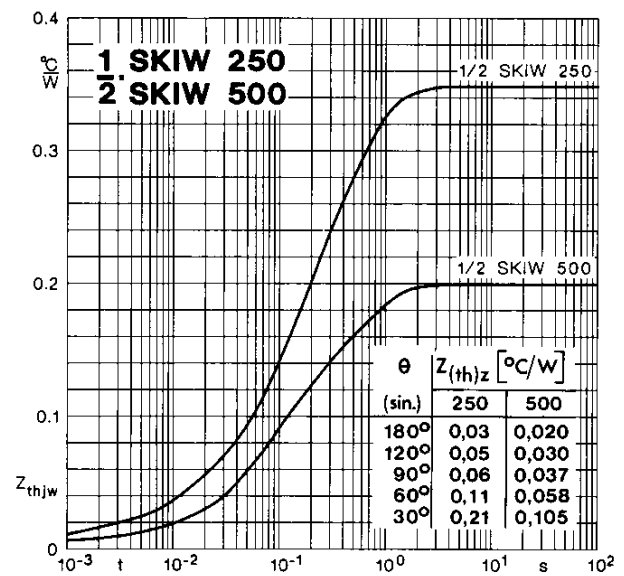

Fig. 7 Transient thermal impedance vs. time

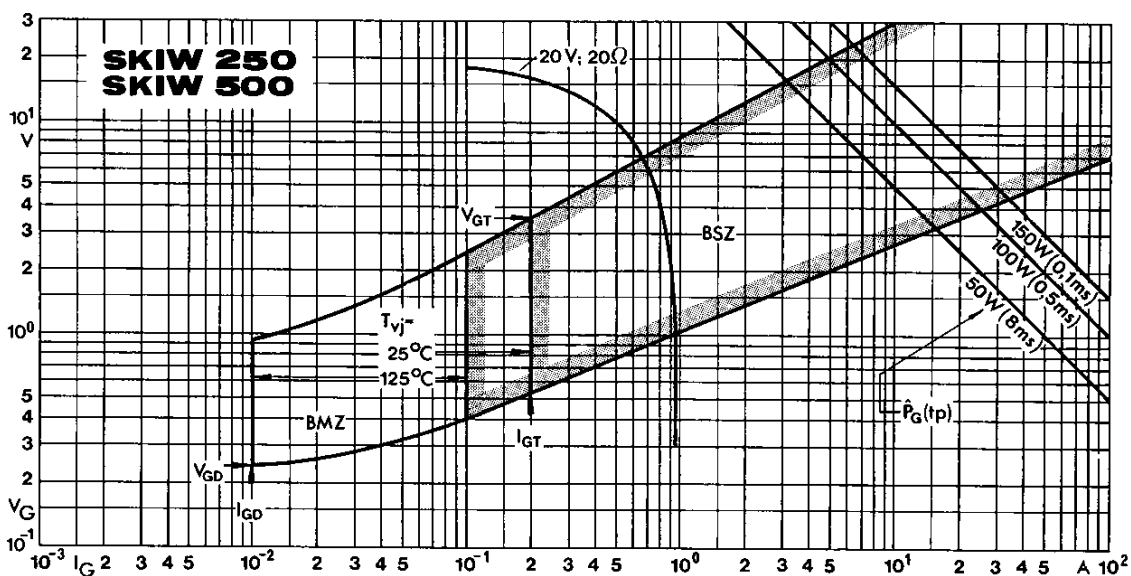
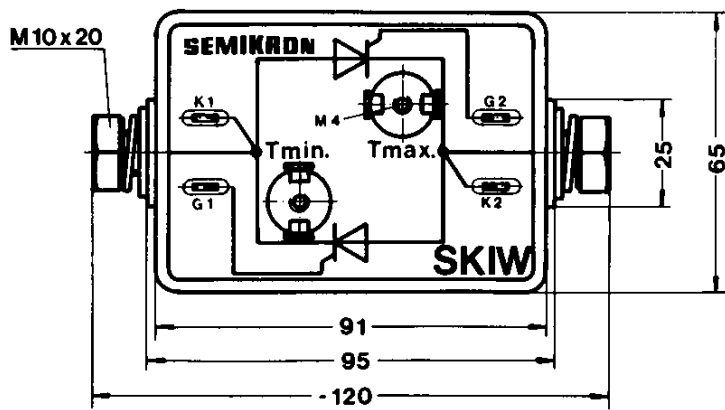
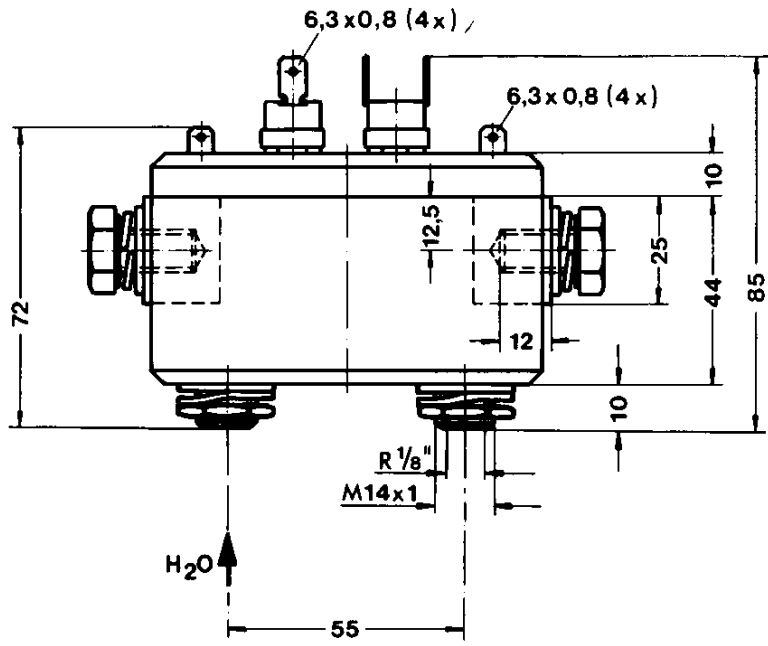

Fig. 8 Gate trigger characteristics

SKIW 250
SKIW 500
Case C 1



Dimensions in mm