

## SEMIPACK® 4 Thyristor Modules

### SKET 330 SKET 400



SKET

#### Features

- Heat transfer through aluminium nitride ceramic isolated metal baseplate
- Precious metal pressure contacts for high reliability
- With amplifying gate
- UL recognized, file no. E 63 532

#### Typical Applications

- DC motor control (e. g. for machine tools)
- Temperature control (e. g. for ovens, chemical processes)
- Professional light dimming (studios, theaters)

V <sub>RSM</sub>	V <sub>RRM</sub> V <sub>DRM</sub>	(dv/dt) <sub>cr</sub>	I <sub>TRMS</sub> (maximum values for continuous operation)	
			600 A	700 A
V	V	V/μs	I <sub>TAV</sub> (sin. 180; T <sub>case</sub> = . . .)	
			380 (68 °C)	440 A (78 °C)
900	800	500	<b>SKET 330/08 D</b>	<b>SKET 400/08 D</b>
1300	1200	1000	<b>SKET 330/12 E</b>	<b>SKET 400/12 E</b>
1500	1400	1000	<b>SKET 330/14 E</b>	<b>SKET 400/14 E</b>
1700	1600	1000	<b>SKET 330/16 E</b>	<b>SKET 400/16 E</b>
1900	1800	1000	<b>SKET 330/18 E</b>	<b>SKET 400/18 E</b>
2100	2000	1000	<b>SKET 330/20 E</b>	–
2300	2200	1000	<b>SKET 330/22 E</b>	–

Symbol	Conditions	SKET 330	SKET 400	Units
I <sub>TAV</sub>	sin. 180; (T <sub>case</sub> = . . .)	330 (78)	400 (84)	A °C
I <sub>D</sub>	B2/B6 T <sub>amb</sub> = 35 °C; P 16/300 F	530 / 665	700 / 880	A
I <sub>RMS</sub>	W1/W3 T <sub>amb</sub> = 35 °C; P 16/400 F	685 / 3 x 550	905 / 3 x 720	A
I <sub>TSM</sub>	T <sub>vj</sub> = 25 °C; 10 ms	9 000	14 000	A
	T <sub>vj</sub> = 130 °C; 10 ms	8 000	12 000	A
i <sup>2</sup> t	T <sub>vj</sub> = 25 °C; 8,3 ... 10 ms	405 000	980 000	A <sup>2</sup> s
	T <sub>vj</sub> = 130 °C; 8,3 ... 10 ms	320 000	720 000	A <sup>2</sup> s
t <sub>gd</sub>	T <sub>vj</sub> = 25 °C I <sub>G</sub> = 1 A			
	di <sub>G</sub> /dt = 1 A/μs	1		μs
t <sub>gr</sub>	V <sub>D</sub> = 0,67 · V <sub>DRM</sub>	2		μs
(di/dt) <sub>cr</sub>	T <sub>vj</sub> = 130 °C		125	A/μs
t <sub>q</sub>	T <sub>vj</sub> = 130 °C		typ. 150 . . . 200	μs
I <sub>H</sub>	T <sub>vj</sub> = 25 °C		150 / 500	mA
I <sub>L</sub>	T <sub>vj</sub> = 25 °C; R <sub>G</sub> = 33 Ω; typ./max.		0,5 / 2	A
V <sub>T</sub>	T <sub>vj</sub> = 25 °C; (I <sub>T</sub> = . . .); max.	2,05 (1500)	1,7 (2400)	V A
V <sub>T(TO)</sub>	T <sub>vj</sub> = 130 °C	1,2	0,92	V
r <sub>T</sub>	T <sub>vj</sub> = 130 °C	0,55	0,3	mΩ
I <sub>DD</sub> ; I <sub>RD</sub>	T <sub>vj</sub> = 130 °C; V = V <sub>DRM</sub> / V <sub>RRM</sub>	120	80	mA
V <sub>GT</sub>	T <sub>vj</sub> = 25 °C; d.c.		2	V
I <sub>GT</sub>	T <sub>vj</sub> = 25 °C; d.c.		200	mA
V <sub>GD</sub>	T <sub>vj</sub> = 130 °C; d.c.		0,25	V
I <sub>GD</sub>	T <sub>vj</sub> = 130 °C; d.c.		10	mA
R <sub>thjc</sub>	cont.		0,09	°C/W
	sin. 180		0,095	°C/W
	rec. 120		0,11	°C/W
R <sub>thch</sub>			0,02	°C/W
T <sub>vj</sub> ; T <sub>stg</sub>			– 40 ... + 130	°C
V <sub>isol</sub>	a. c. 50 Hz; r.m.s.; 1 s/1 min		3600 / 3000	V~
M <sub>1</sub>	to heatsink to terminals } SI (US) units		5 (44 lb. in.) ± 15 % <sup>1)</sup>	Nm
M <sub>2</sub>			17 (150 lb. in.) ± 15 % <sup>2)</sup>	Nm
a			5 · 9,81	m/s <sup>2</sup>
w	approx.		940	g
Case	→ page B 1 – 94		A 36	

<sup>1)</sup> See the assembly instructions

<sup>2)</sup> The screws must be lubricated

ET33001a

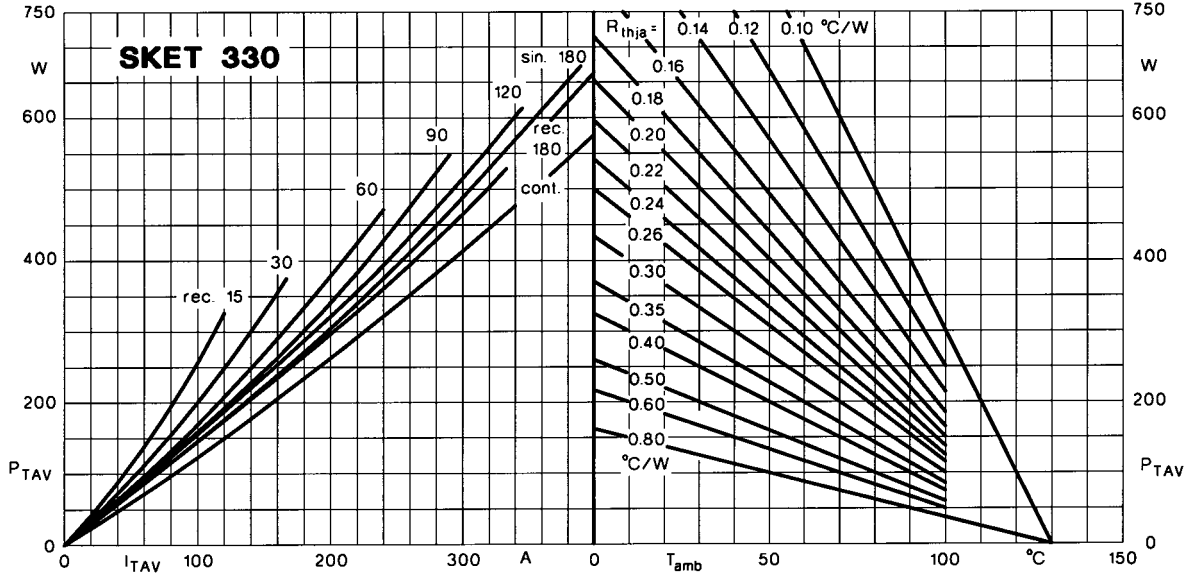

Fig. 1 a Power dissipation vs. on-state current and ambient temperature

ET40001b

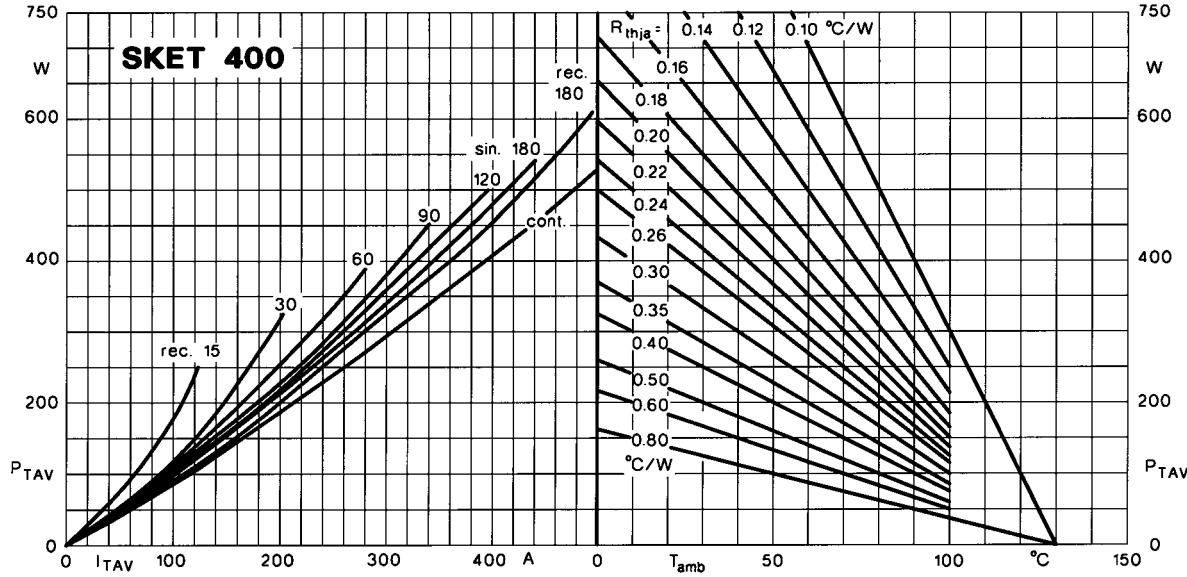

Fig. 1 b Power dissipation vs. on-state current and ambient temperature

ET40006

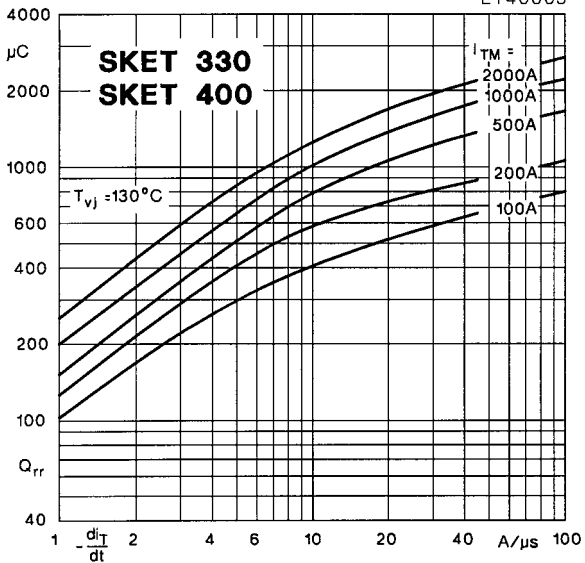

Fig. 5 Recovered charge vs. current decrease

ET40006

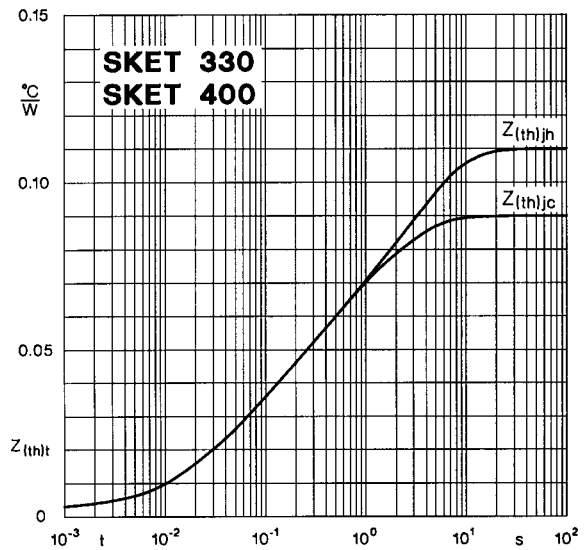

Fig. 6 Transient thermal impedance vs. time

ET40007

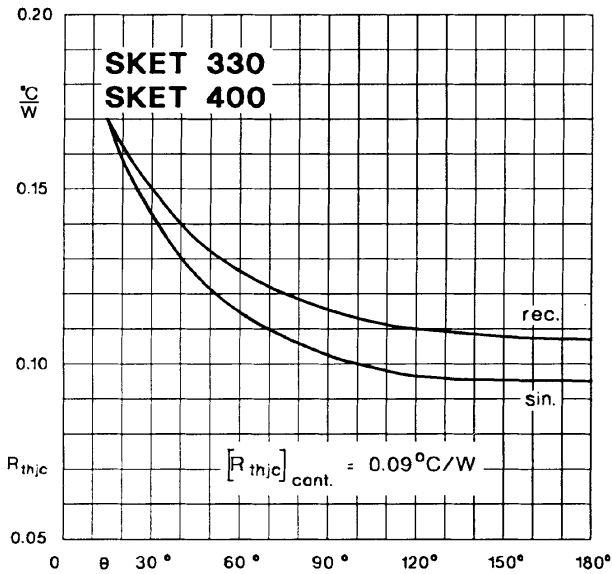

Fig. 7 Thermal resistance vs. conduction angle

ET33008a

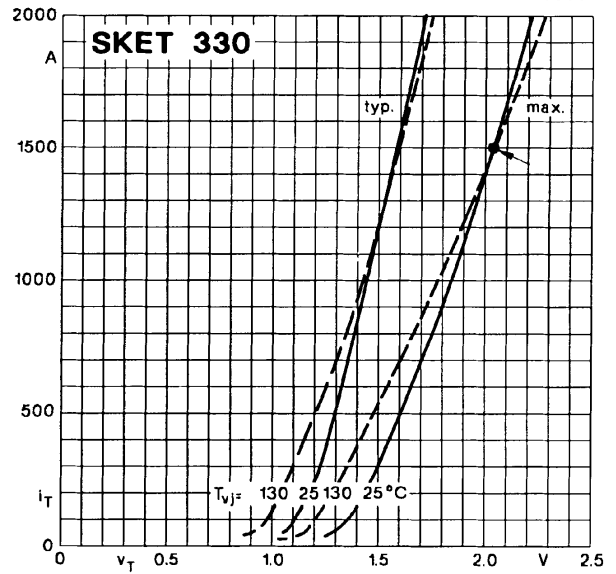

Fig. 8 a On-state characteristics

ET40008b

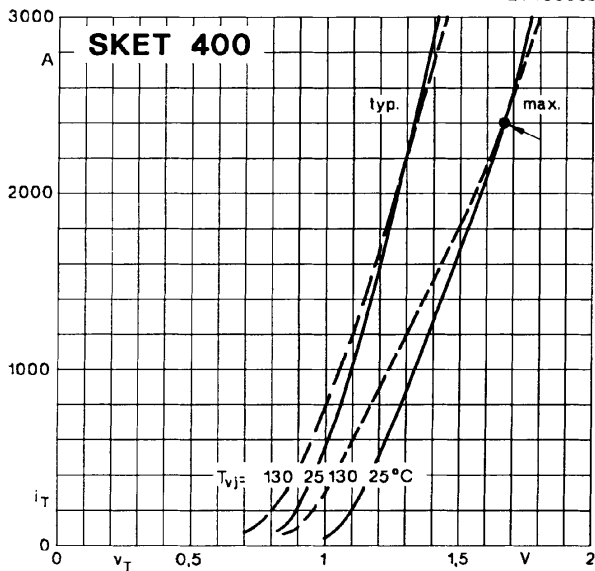

Fig. 8 b On-state characteristics

ET40009

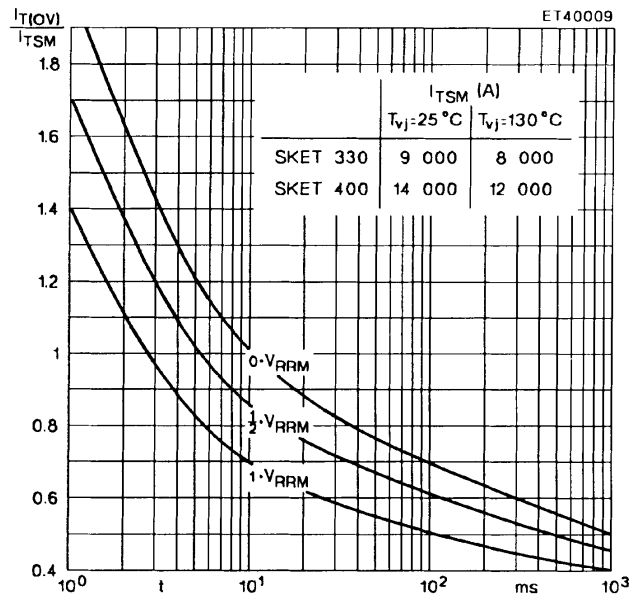

Fig. 9 Surge overload current vs. time

ET33010

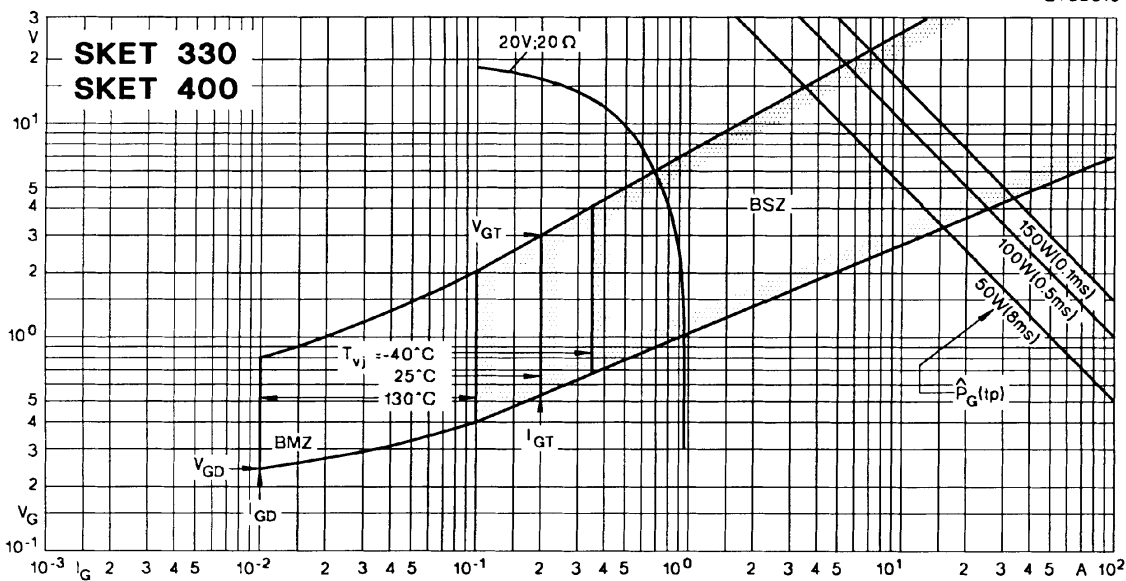
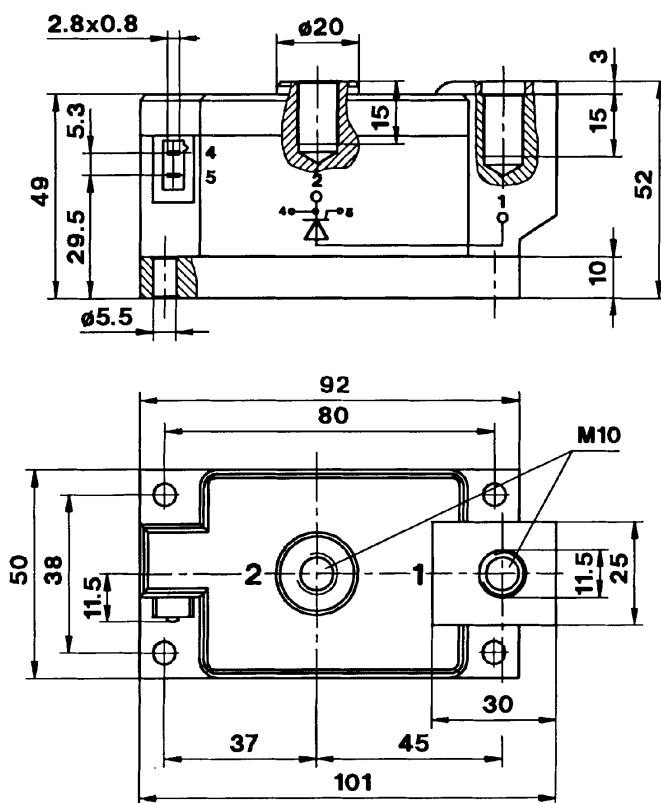

Fig. 10 Gate trigger characteristics

**SKET 330**  
**SKET 400**

Case A 36  
SEMIPACK® 4



Dimensions in mm

**SKKE 400**

Case A 42  
SEMIPACK® 4

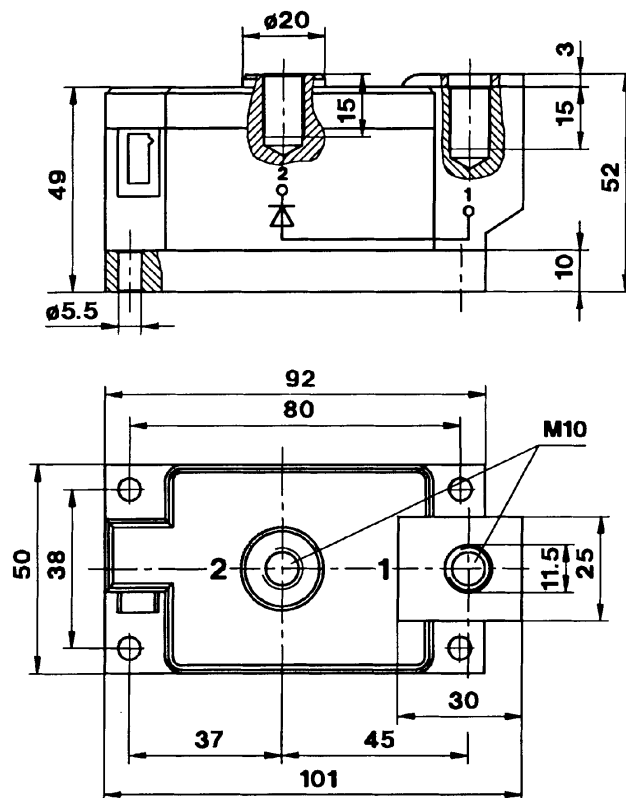

Dimensions in mm