

## SEMIPONT® 4 Power Bridge Rectifiers

SKD 110  
SKD 160

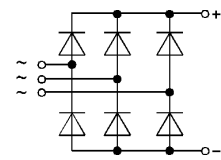

SKD

### Features

- Robust plastic case with screw terminals
- Large, isolated base plate
- Blocking voltage to 1800 V
- High surge currents
- Easy chassis mounting
- UL recognized, file no. E 63 532

### Typical Applications

- Three phase rectifiers for power supplies
- Input rectifiers for variable frequency drives
- Rectifiers for DC motor field supplies
- Battery charger rectifiers

$V_{RSM}$ $V_{RRM}$	$I_D$ ( $T_{case} = 100\text{ °C}$ )	
	110 A	160 A
200 V	SKD 110/02	SKD 160/02
400 V	SKD 110/04	SKD 160/04
800 V	SKD 110/08	SKD 160/08
1200 V	SKD 110/12	SKD 160/12
1400 V	SKD 110/14	SKD 160/14
1600 V	SKD 110/16	SKD 160/16
1800 V	SKD 110/18*	SKD 160/18*

Symbol	Conditions	SKD 110	SKD 160	Units
$I_D$	$T_{case} = 100\text{ °C}$	110	160	A
	$T_{amb} = 45\text{ °C}$ , chassis <sup>1)</sup> P1/200	28	30	A
		70	75	A
	$T_{amb} = 35\text{ °C}$ , P1/120 F P3/120 F	110	145	A
123		146	A	
$I_{FSM}$	$T_{vj} = 25\text{ °C}$ , 10 ms	1200	1800	A
	$T_{vj} = 150\text{ °C}$ , 10 ms	1000	1500	A
$i^2t$	$T_{vj} = 25\text{ °C}$ , 8,3...10 ms	7200	16 200	A <sup>2</sup> s
	$T_{vj} = 150\text{ °C}$ , 8,3...10 ms	5000	11 200	A <sup>2</sup> s
$V_F$	$T_{vj} = 25\text{ °C}$ ; $I_F = 300\text{ A}$	1,9	1,65	V
$V_{(TO)}$	$T_{vj} = 150\text{ °C}$	0,85	0,85	V
$r_T$	$T_{vj} = 150\text{ °C}$	4	3	mΩ
$I_{RD}$	$T_{vj} = 25\text{ °C}$ ; $V_{RD} = V_{RRM}$	0,5	0,5	mA
	$T_{vj} = 150\text{ °C}$ ; $V_{RD} = V_{RRM}$	5	6	mA
$R_{thjc}$	per diode	0,9	0,65	°C/W
	total	0,15	0,11	°C/W
$R_{thch}$	total	0,03		°C/W
$T_{vj}$		- 40 ... + 150		°C
$T_{stg}$		- 40 ... + 125		°C
$V_{isol}$	a.c. 50...60 Hz; r.m.s.; 1 s / 1 min	3600 / 3000		V~
$M_1$	to heatsink	SI units	$5 \pm 15\%$	Nm
		US units	$44 \pm 15\%$	lb. in.
$M_2$	to terminals	SI units	$5 \pm 15\%$	Nm
		US units	$44 \pm 15\%$	lb. in.
$w$		270		g
Case		G 37		

\* Available in limited quantities

<sup>1)</sup> Painted metal sheet of minimum 250 x 250 x 1 mm:  $R_{thca} = 1,8\text{ °C/W}$

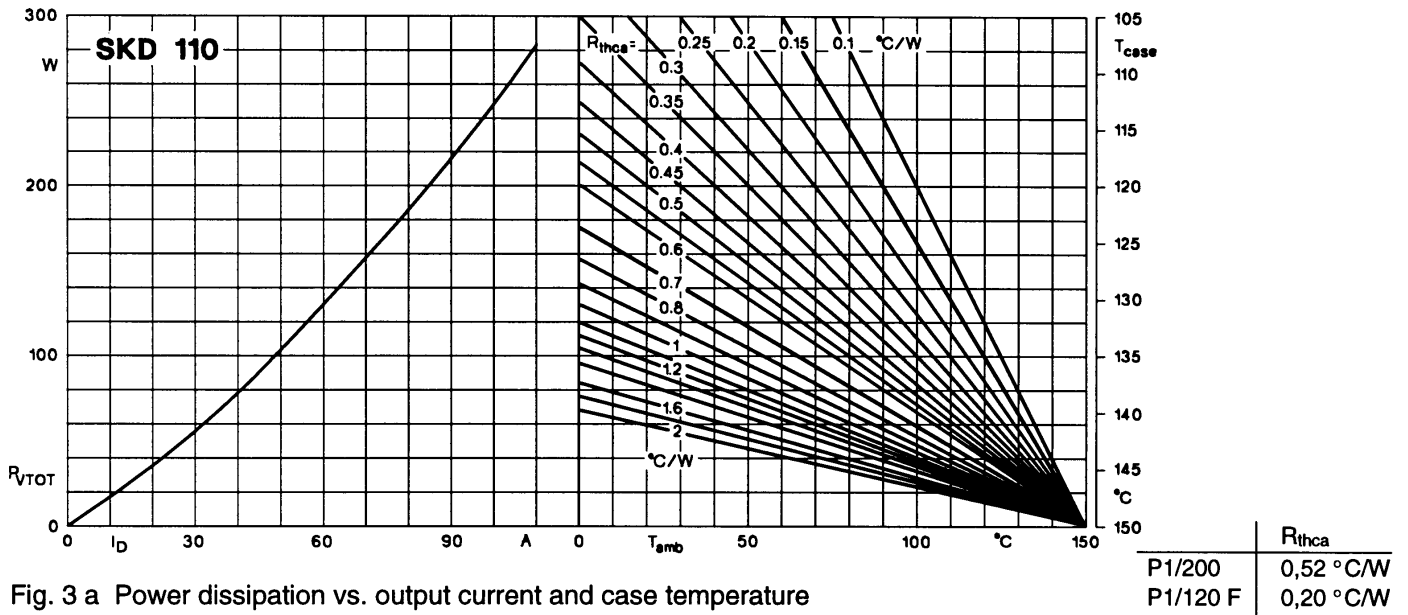

Fig. 3 a Power dissipation vs. output current and case temperature

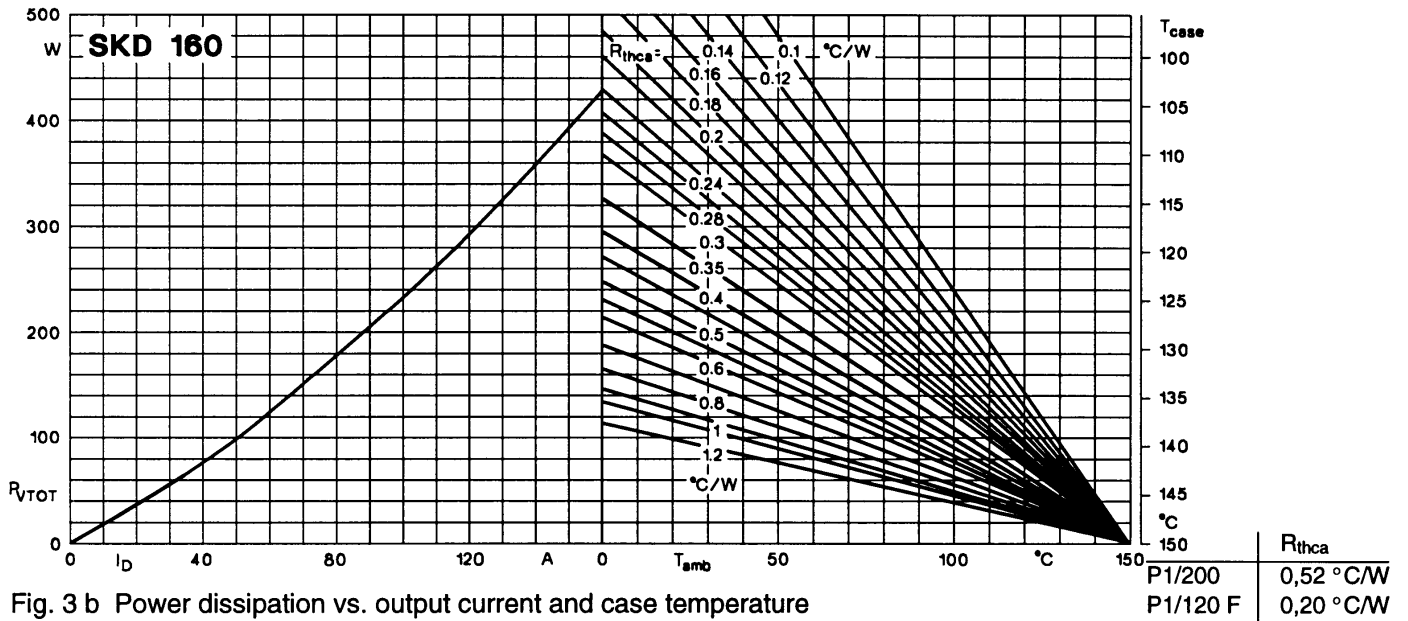

Fig. 3 b Power dissipation vs. output current and case temperature

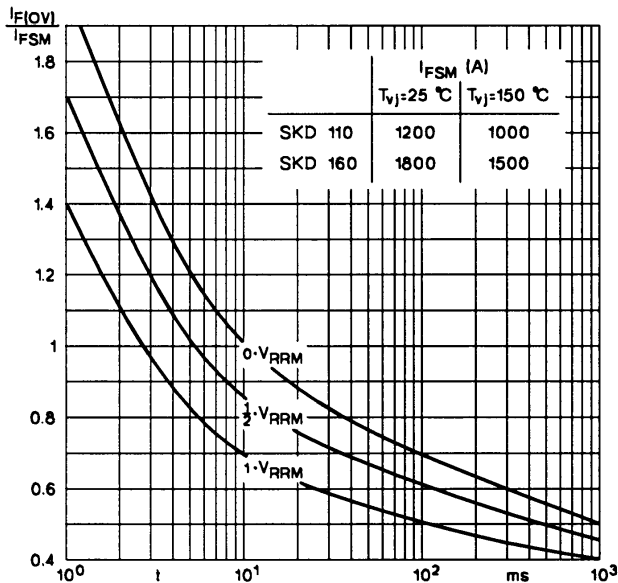

Fig. 5 Surge overload current vs. time

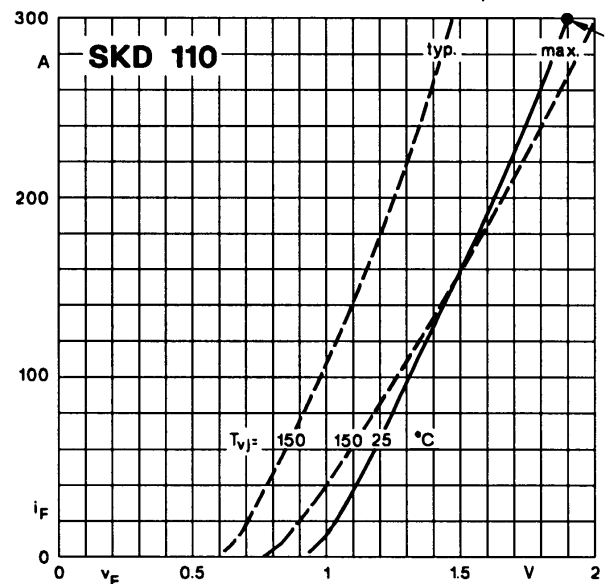

Fig. 9 a Forward characteristics of a single diode

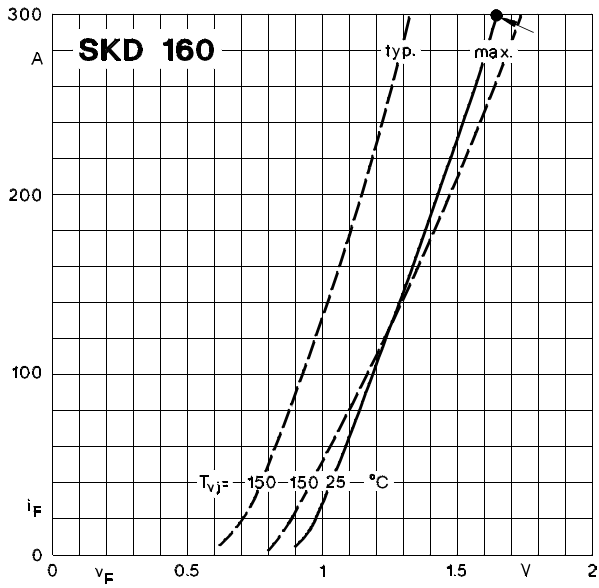

Fig. 9 b Forward characteristics of a single diode

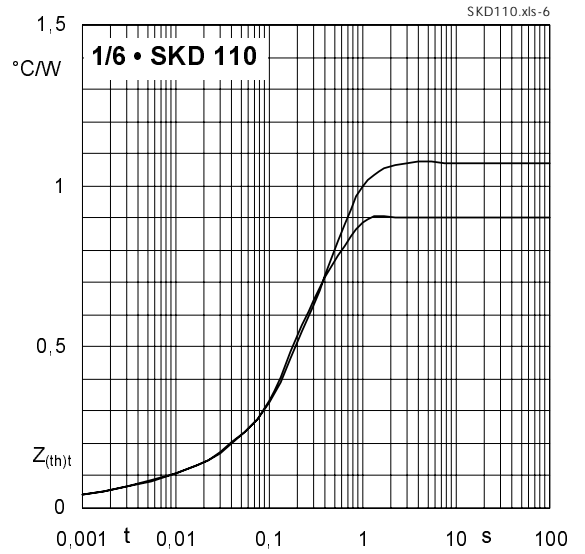

Fig. 12 a Transient thermal impedance vs. time

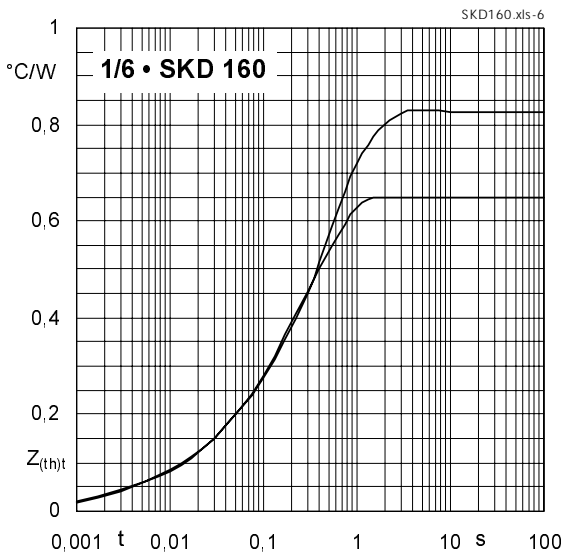
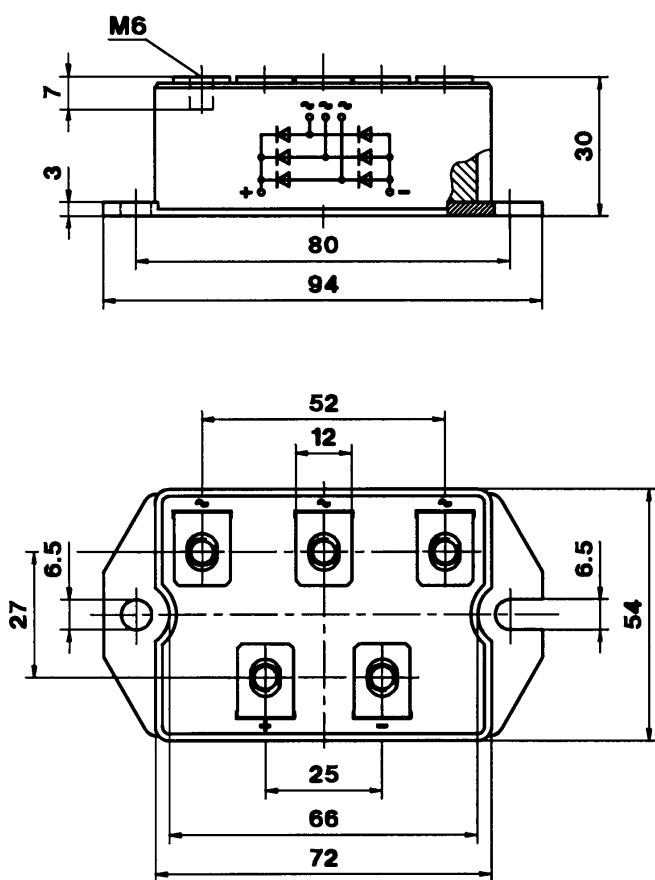

Fig. 12 b Transient thermal impedance vs. time

SKD 110  
SKD 160

SEMIPONT® 4

Case G 37



Dimensions in mm